



Transform, together



Company Portfolio
2026

www.vcaretechnologies.net

Table of Content

01 Who we are ?

02 Creators

03 Our Expertise

04 Projects / Case Studies

05 Our Clients

06 Client Testimonials

Who We Are ?

V Care Technologies:

Your trusted technology partner for business growth.

Established in 2011:

A decade of experience in crafting customized IT solutions.

Tailor-made Solutions:

Expertise in web, software, and mobile app development for unique business needs.

Enhanced Efficiency:

Streamlined processes and user-friendly designs for seamless operations.

Cutting-edge Technology:

Embracing the latest advancements to empower businesses.

Enduring Relationships:

Committed to long-term partnerships and unwavering support.

Global Expansion – United Arab Emirates (2026):

Verge Technologies is the UAE division of V Care Technologies



Industry We Served

We value our customers as a foundation of our business and pride ourselves on delivering a quality service which is both professional and friendly.



Healthcare



Finance



Retail

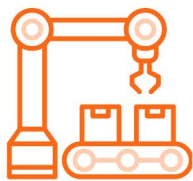

Manufacturing



Energy & Utilities



Real Estate



E-commerce



Hospitality



Transportation



Education

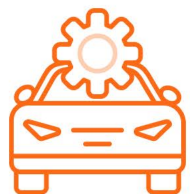

Automotive



Government

And many more...

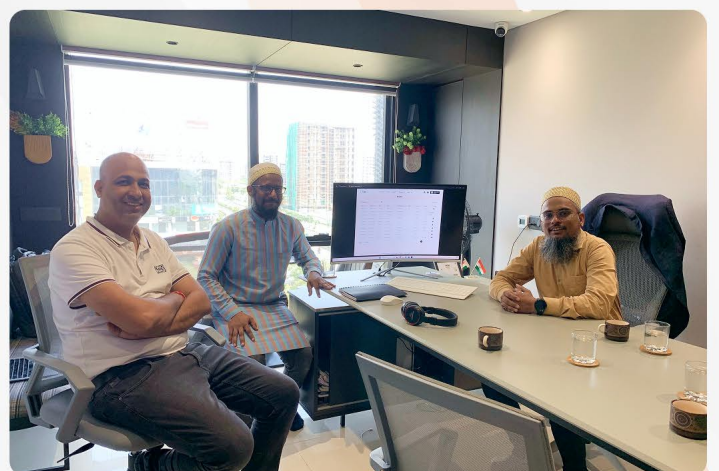

Our Mission

We are on a mission to help entrepreneurs of small and medium businesses to automate their business process that can increase productivity and save time by making best use of technology which makes business process faster and life easier.

15+

Years of Experience

750+

Projects

270+

Clients

5+

Countries

15+

Teams

Process for the project



What do you get from us?

Empower

Unleash the potential of your business with innovative technology.

Transform

Experience a paradigm shift in efficiency and productivity.

Simplify:

Complex processes become effortless with user-centric designs.

Innovate:

Stay ahead of the curve with cutting-edge technology solutions.

Partner:

Experience the power of collaboration and unwavering support.

Creators



Murtuza Tarwala

FOUNDER

Murtaza Tarwala is a Techno thinker who founded V Care Technologies at a very young age of 21 as he has always been passionate about helping people take utmost benefit of technology that can make their life easier and to make this world a better place to live .



Sakina Vohra
Administrator



Abdeali Kachwala
Project Manager



Deshna Shah
BDE



Vihang Kapadiya
UX Designer



Viral Rakholiya
Web Developer



Rohan Champaneri
Sr. Mobile App Developer

Creators



Farida Rupawala
Web Developer



Digvijay Singh Indawat
Fullstack Developer



Rutvik Bhaliya
Jr.Mobile App Developer



Jay Makwana
Front-End Developer (Intern)



Manav Variya
Video Editor



Ahmed Rangoonwala
Social Media Manager



Fahad Shaikh
SEO Expert

ORGANOGRAM

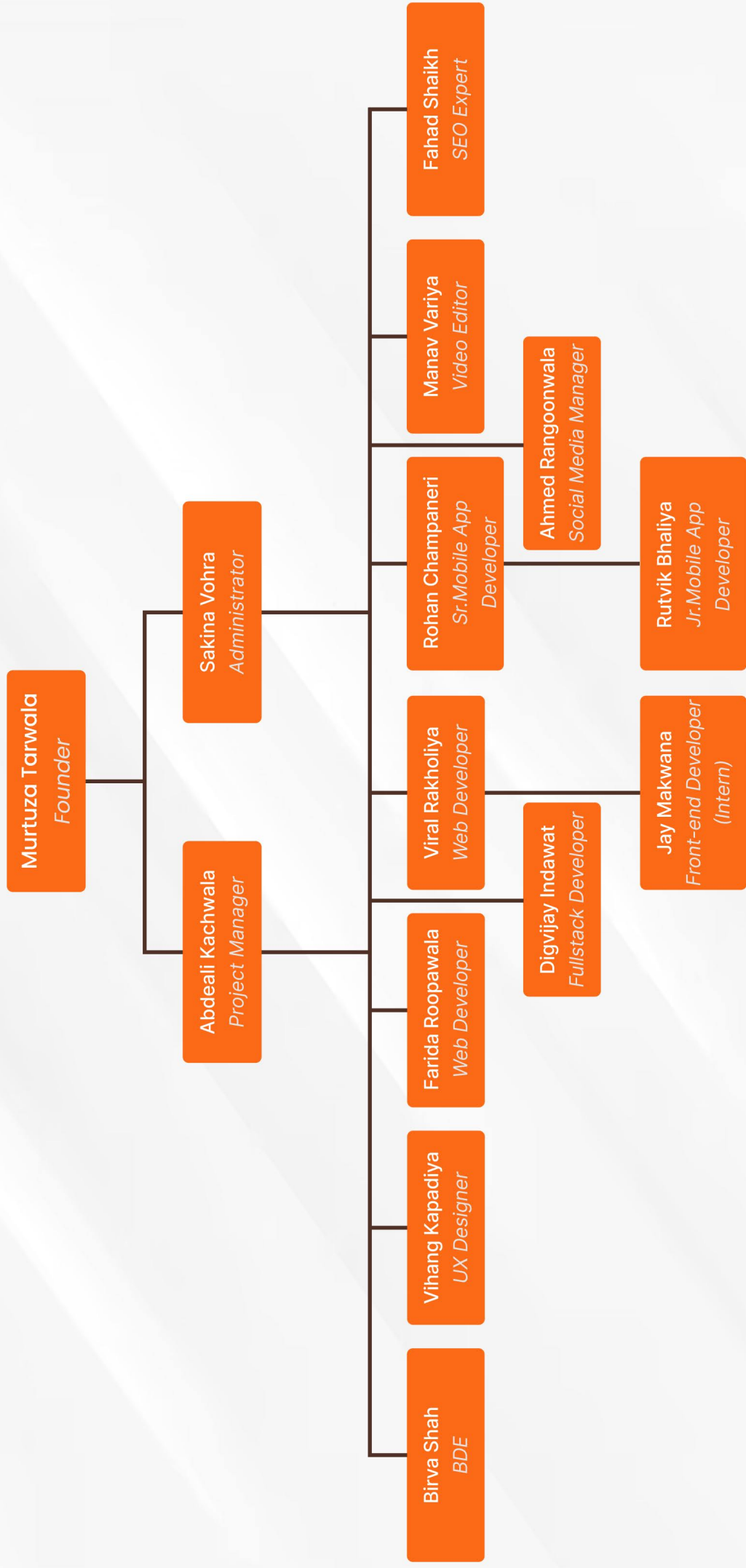

Our Expertise



UX / UI Designing



Website Designing



Software Development



E-commerce Website



Mobile Applications



QA Testing & Audit



GIS Mapping



Chatbot



Independent Web based
Tool & Add-ons



Generative AI / LLM (Large
Language Model)
(Upcoming)



Branding



SEO / SMO / ASO

Case Study



FAST - First Aid For Students And Teachers (Mobile App)

Client

NDMA (National Disaster Management Authority) Indian Red Cross Society (National Headquarters, New Delhi)

Segment :

Health and Wellness/ Education/ Emergency preparedness

Endorsement / Impact / Success

- Endorsed by Prime Minister, Home Minister, Ministry of Health & Family Welfare, Ministry of State for Home Affairs.
- This App has been now introduced into Education Policy.

Project Scope

- We created an app in 2 segments. one for teachers & parents & other one for children (with child friendly animated designs).
- This app helps the teachers & children's in schools to provide basic first aid knowledge along with pictorial format & instruction for How to do.
- This app also contains Facts about first aid, History about first, emergency calling facility.

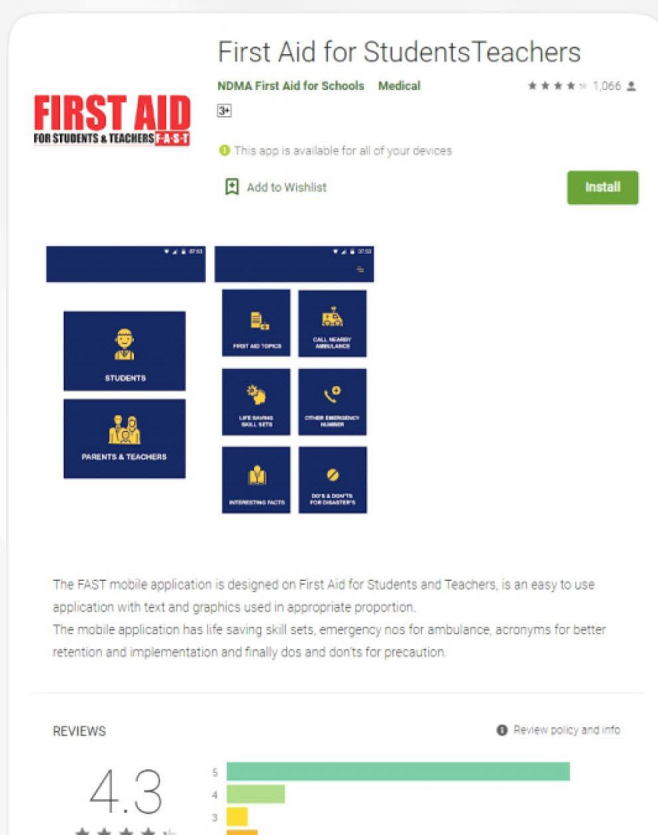



प्रधान मंत्री
Prime Minister

MESSAGE

It is a pleasure to know that a First Aid Manual and a Mobile App have been developed by the National Disaster Management Authority (NDMA) in collaboration with the Indian Red Cross Society (IRCS) exclusively for the training of school children and teachers in first aid skills.

A resilient and responsive disaster management system at ground level is imperative for the success of Disaster Management framework of any nation. Being a diverse geographic entity, India has to cope with disasters of diverse dimensions and in this context our preparedness should start from the school itself.

I appreciate the NDMA and IRCS for their initiatives in building a disaster resilient culture among students.

Best wishes for this new initiative and for all their future endeavours in this domain.

(Narendra Modi)

New Delhi
23 May, 2018

राजनाथ सिंह
RAJNATH SINGH



गृह मंत्री
भारत
नई दिल्ली-110001
HOME MINISTER
INDIA
NEW DELHI-110001



MESSAGE

I am delighted to know that National Disaster Management Authority (NDMA) and India Red Cross Society (IRCS) have jointly developed First Aid manuals and a mobile app to build the capacity of teachers as well as schoolchildren in providing emergency healthcare.

I am happy to learn that these manuals aim to equip the readers with requisite techniques to save precious human lives. The knowledge and skills thus learnt, by teachers and students alike, will come in handy and I am sure this could save lives of many people.

I appreciate their initiative and convey my heartiest congratulations to all associated in this endeavour. I wish this project a grand success.

(Rajnath Singh)

Office : Room No. 104, Ministry of Home Affairs, North Block, New Delhi-110 001
Tel. : 23002462, 23004686, Fax : 23004221
E-mail : hm@nic.in

किरेन रीजीजू
KIREN RIJJU



गृह राज्य मंत्री
भारत सरकार
MINISTER OF STATE FOR
HOME AFFAIRS
GOVERNMENT OF INDIA



I am glad that NDMA, in collaboration with Indian Red Cross Society (IRCS), has come out with First Aid manuals and a mobile app for training teachers and schoolchildren in administering first aid.

Children spend more time in schools than elsewhere. It is, therefore, imperative that a safe environment is created for them. One way of doing it is by introducing the concept and techniques of first aid to teachers as well as schoolchildren. Children trained in first aid can also prove to be life savers in disaster situations.

I am informed that these manuals and the mobile app have used very simple, age-appropriate language along with graphical depictions of first aid techniques to substantiate the content.

Since children also act as agents of change: and lessons learnt at school are often passed on to family, friends and neighbours, I am sure this initiative, over the years, will build a safer and more aware society.

I appreciate the efforts of all those who have contributed towards developing these manuals and call upon all the stakeholders to work together to make this project a success.

(Kiren Rijju)

4th May, 2018
New Delhi.

Office : Room No. 127, North Block, New Delhi-110 001 Tel. : 23094054 Fax : 23093549



जगत प्रकाश नड्डा
Jagat Prakash Nadda



स्वास्थ्य एवं परिवार कल्याण मंत्री
भारत सरकार
Minister of Health & Family Welfare
Government of India



Message

I am glad to know that the Indian Red Cross Society (IRCS) and the National Disaster Management Authority (NDMA) have together developed the 'First Aid Training' Modules for school teachers and students.

2. There is no denying the fact that First Aid administered at the right moment can make a vast difference between life and death for victims of accidents and calamities battling for their lives. This underscores the importance of First Aid and the need to train more and more number of people in this life saving skill, so that there is no dearth of good samaritans in times of trauma and calamity. Imparting training in life saving skills to young students makes them both responsive and responsible citizens.

3. The First Aid Training Module jointly developed by IRCS and NDMA is a step in this direction. Making the First Aid Training Module as an easy to access Mobile phone App adds digital value to the training process.

4. While commending the concerned IRCS and NDMA teams for their laudable initiative, I wish for success of the First Aid Training Module.

(Jagat Prakash Nadda)

348, ए-स्कंध, निर्माण भवन, नई दिल्ली-110011
348, A-Wing, Nirman Bhawan, New Delhi - 110011
Tele.: (O) : +91-11-23061661, 23063513, Telefax : 23062358, 23061648
E-mail : hfwminister@gov.in

I-Chat - Interactive Chatbot

(Chatbot Based Methodological Survey Tool)

Client

Govt. of Nagaland

Key Feature

- Minimum Data Capture Methodology.
- Despite of having several IT Companies in all over India, who already had done several things in times of covid-19. We are the only firm who had contributed at this level.
- Chatbot has been made so easy to use and simple in design that it has been easily adoptable in slum areas and used in several cities.

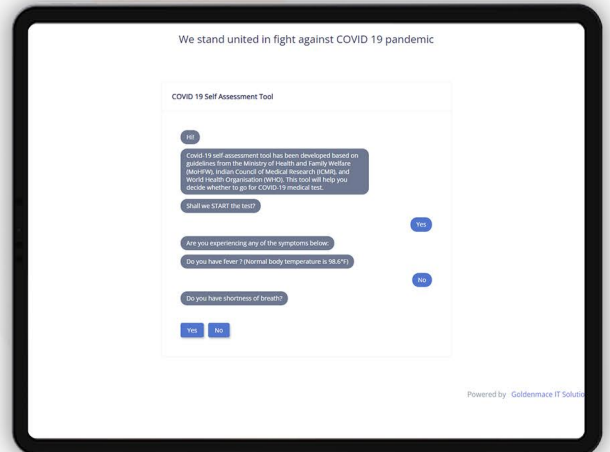
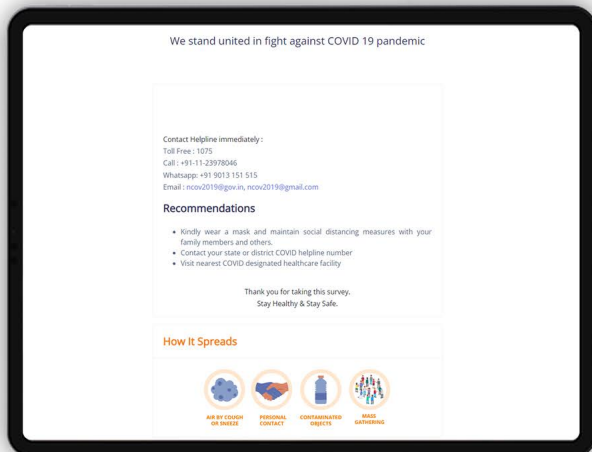
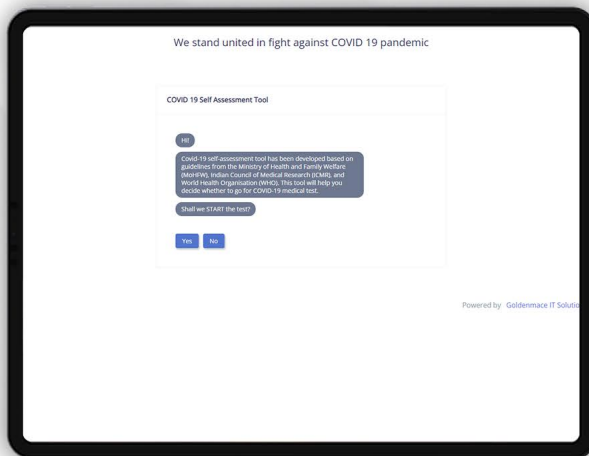
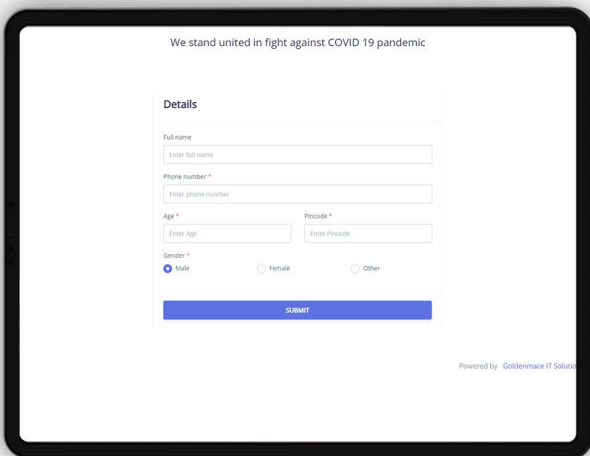

https://easternmirrornagaland.com/self-assessment-tool-for-covid-19-now-in-nagaland/

EASTERN MIRROR

HOME NEWS ARTS AND ENTERTAINMENT LIFESTYLE SCIENCE AND TECH SPORTS OPINION FEATURE PHOTO GALLERY E-PAPER

Home > Nagaland > Self-assessment tool for Covid-19 now in Nagaland

NAGALAND

Self-assessment tool for Covid-19 now in Nagaland

By Our Reporter
Updated: Apr 02, 2020 1:20 am

Our Reporter
Dimapur, April 1 (EMN): Based on the guidelines of the Ministry of Health and Family Welfare, the Indian Council of Medical Research (ICMR) and World Health Organisation (WHO), a self-assessment tool has been introduced in the state by the Nagaland State Disaster Management Authority (NSDMA) and government of Nagaland in collaboration with Institution for Disasters, Emergency and Accidents (Idea).

The online tool will help the public decide whether they should be tested for Covid-19 by answering a few questions related to age, symptoms, travel or contact history and pre-existing health conditions.

Speaking to Eastern Mirror, the officer on special duty (OSD), NSDMA, Johnny Ruangmei, said that the self-assessment tool is mainly to reduce the workload of health workers in screening the public.

Thanks for your feedback.
Ad choices

CITY	SLUM LOCATION	PARTNER/NGO
Mumbai	Dharavi, Bainganwada, Janupada	World Vision
Delhi	Kusumpur Pahari, New Ashok Nagar	World Vision
Kolkata	Pilkhana, Tikipara	CBM
Chennai	Vaysarpari, Kasimedu, Royapuram	Arunodaya
Indore	Krishnapura	SEWA
Srinagar	Near Dal Lake (scattered near shrines)	Srinagar Municipal Corporation
Shillong	Muwbah, Demseniong, Pythobrumkrab	Ms Rinibeth, Social worker Ms Rukini, Social worker
Surat	Katagam, Mota Varachha, Dindoli, Vesu	SEWA
Jaipur	Kathputli	Ms Kavita Srivastava, Ms Komal Srivaatava Institute for Equity Studies
Agra	Nagla Chand, Gulab Nagar Shanti Vihar	Mr Mohd Harun Imam Sahib Mr Hari Mohan

Urban Survey

Dear Friend

Welcome to the Survey, which is being taken for understanding the needs of the population, who have been extensively hit by COVID 19.

What is COVID-19

It is a virus. It is a disease. It is a film



Sarvekshan - Interactive Chatbot (Advanced Version)

Key Feature

- Live & Dynamic Dashboard.
- Multi Surveys can run simultaneously.
- Multi-Lingual Support Multi-Function Option : Single option selection, Multi Select option, Text Area, Option for Skip, Emojis, etc.
- Certificate Generation

Please select your language

English हिंदी ગુજરાતી मराठी

বাংলা தமிழ் తెలుగు ਪੰਜਾਬੀ

ಕನ್ನಡ ಕರಾವಳಿ

Do you want to participate in this survey?

YES NO

1 Gender

Male Female

Others

NEXT

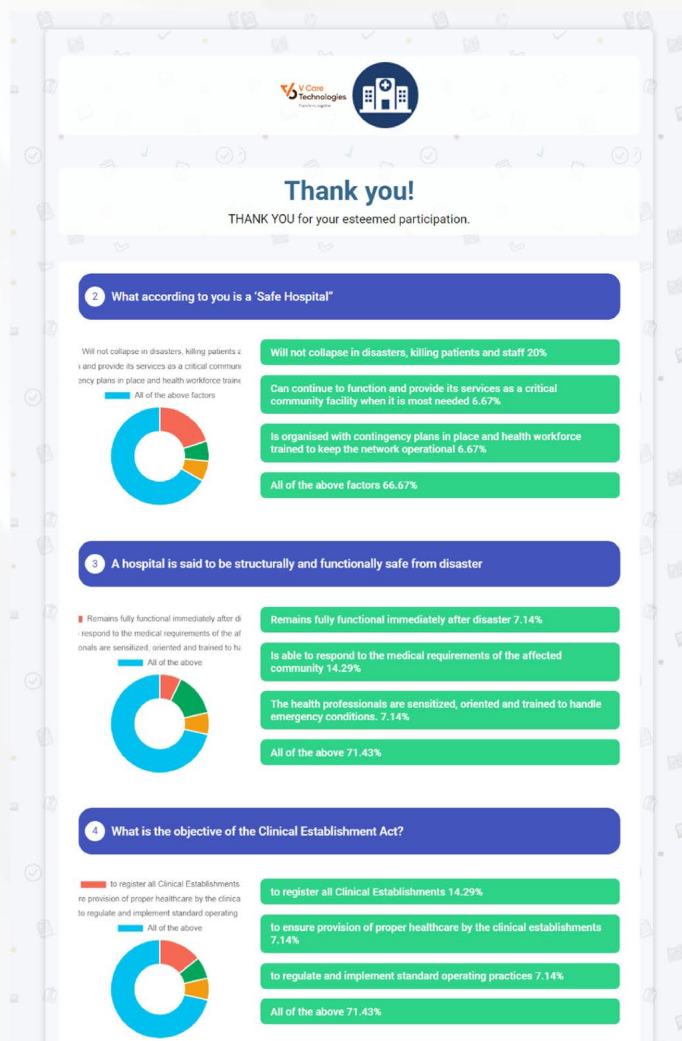



Learning Management System

LMS Online Exams enables you to reliably deliver high-quality exams to students, simultaneously and with no limit on student numbers. It's designed to meet the needs of any organization, offering a system that allows online exams to be delivered at small or large scale, depending on your needs. Also generates result instantly. Also includes other features of interactive classroom to present alongwith learning and it also facilitates Online Library for users.

Client

Institutes and Organization

Segment :

Education, Exam Portal

Users:

Students, Teachers, Admin

Key Features:

- Examination Module Student Area Teacher Area & Admin Area
- Previous scheduled exams history
- Interactive Classroom/Presentation Mode - Communicating with users in realtime
- Over 1 Lakh Users Take Online Exams Monthly.
- Online Library
- Batch Mangment
- Mock exams
- Language Support
- Batch wise results
- Performance Analytics
- Certificates Generation
- User Management
- Real-Time Monitoring
- Discussion Forums
- Live student login data
- Discussion Forums

Upcoming

Use of AI for Content-based test generation, Question Set suggestions and many more

Online Exam & Assessment Control System Vaghaladhara Vibhag Kelvani Mandal

Trade
Total Courses

27

Students
Total Students

426

Scheduled Exams
Total Pending Exam

43 / 43

Live Login Data
Total Login Students

22

SHRI VAGHALDHARA VIBHAG KELVANI MANDAL,
Recognized by DEVELOPMENT SUPPORT AGENCY OF GUJARAT,
TRIBAL DEVELOPMENT DEPARTMENT, GUJARAT

MARKSHEET

Marksheet No. 3373

This is to Certify that Mr./Ms **TEJALBEN RAMESHBHAI PAVAR Son** / Daughter of **RAMESHBHAI** Date of Birth 18/04/2005 Enrolment No. 231286811414 has successfully cleared the assessment in the job roll / qualification Industrial Sewing Machine Operations of Duration 4 months Earning 24 Credits at NSQF Level 3 at Training Centre Shri Nathubhai & Smt. Parvatiben N. Desai, Vocational Training Centre, I.T.I, Vaghaladhara, District Valsad State Gujarat with 76.5 % Grade

S.No.	Summative Assessment	Max. Marks	Min. Pass Marks	Marks Secured
1	Paper -1 (Trade Theory)	100	33	48
2	Paper -2 (Employability Skill)	50	17	38
3	Paper -5 (Trade Practical)	250	150	220
Total		400	200	306

Result: **Pass**

Place of Issue: VTC Vaghaladhara Date of Issue: 30-03-2024

M. P. Desai
Principal
Vocational Training Centre
Vaghaladhara

Name: MITALIBEN NAVINBHAI BHIMSEN
Roll No.: 230889842122
Session: Session-1
Trade: [421] Computer Operator and Programming Assistant
Quarter: UNIT02
Paper:

Date: 02/11/2023
Time: 1h 59m 48s
100%

Question 1 of 75

Which feature is used to create a newspaper type document?

જાણકારી મળતી હોય તે અભાવ માટે સર્વ સુવિધાની ઉપલબ્ધિ મળે છે?

A. Tables
સેલ

B. Tab stops
ટેબ સ્ટોપ

C. Columns
સ્ટામ્પ

D. Bullets and numbering
ગુણકો અને નંબરો

A
 B
 C
 D

Question Palette

1	2	3	4	5	6
7	8	9	10	11	12
13	14	15	16	17	18
19	20	21	22	23	24
25	26	27	28	29	30
31	32	33	34	35	36
37	38	39	40	41	42
43	44	45	46	47	48
49	50	51	52	53	54
55	56	57	58	59	60
61	62	63	64	65	66
67	68	69	70	71	72
73	74	75			

Answered Not Answered
 Flagged Not Visited

Clear Answer
Start Exam
Flag
Previous
Next

SHRI VAGHALDHARA VIBHAG KELVANI MANDAL,
Recognized by DEVELOPMENT SUPPORT AGENCY OF GUJARAT, TRIBAL DEVELOPMENT
DEPARTMENT, GUJARAT

CERTIFICATE FOR SKILL COMPETENCY

Certificate No. 23239

This is to Certify that Mr./Ms **KRUNALBHAI KISHORBHAI MAHLA Son** / Daughter of **KISHORBHAI** Date of Birth 23/07/2006 Enrolment No. 230886899014 has successfully cleared the assessment in the job roll / qualification Architectural Draughtsman of Duration 24 months Earning 24 Credits at NSQF Level 4 at Training Centre Shri Nathubhai & Smt. Parvatiben N. Desai, Vocational Training Centre, I.T.I, Vaghaladhara, District Valsad State Gujarat with 60.25 % Grade

Place of Issue: VTC Vaghaladhara Date of Issue: 28-03-2024

M. P. Desai
Principal
Vocational Training Centre
Vaghaladhara

S. J. Desai
Project Administrator
Tribal Sub Plan
Valsad

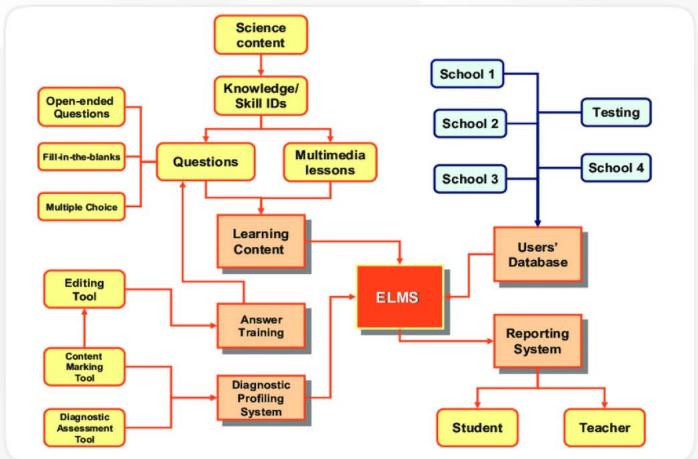



Digital Card (Product)

A digital business card is an electronic version of a traditional printed business card that can be easily shared via a smartphone or other electronic device. Instead of carrying physical business cards, which can be easily lost or damaged, a virtual digital business card allows professionals to share their contact information with potential clients, customers, and colleagues quickly and easily.

Segment :

SAAS Product, Digital Card

Key Features:

- Custom colors and theme change
- Live Geo-Location Tracking
- QR Code
- Link Sharing
- Social Media Integration
- Text Change
- Visitor Counts
- Add services/products with Images

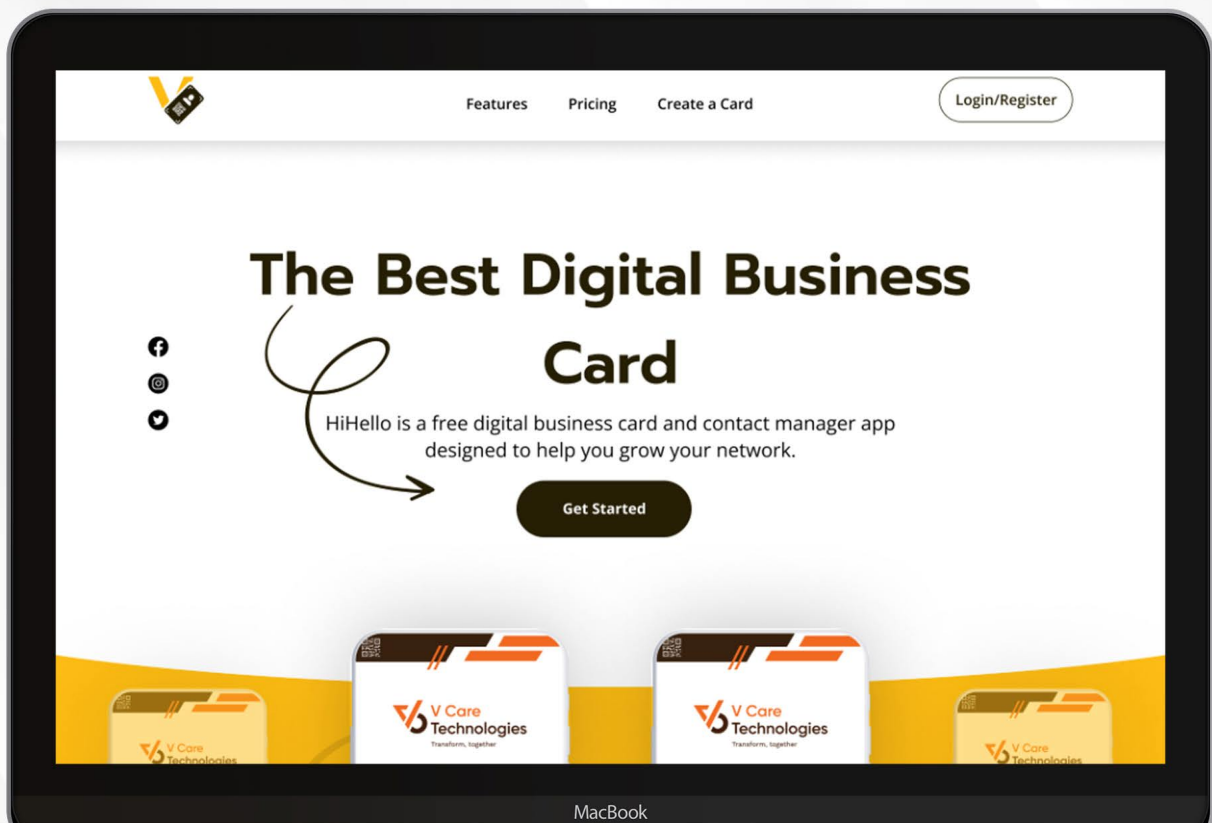

A virtual digital card is a versatile tool for various professionals and individuals & is currently being used by :

Business Organizations:

Anytime team changes new digital card can be created with simple steps.

MSMEs:

Track sales team location and no. of cards accessed. Digital card is helpful for impressing clients.

Entrepreneurs/ Solopreneurs:

While conducting online meeting you can share your digital card to stay in your customer's contact.

Freelancers:

Digital card can be used for showcasing your portfolio, project/services display as they work overseas.

Students/ Interns:

They can showcase their resume and easy for sharing.

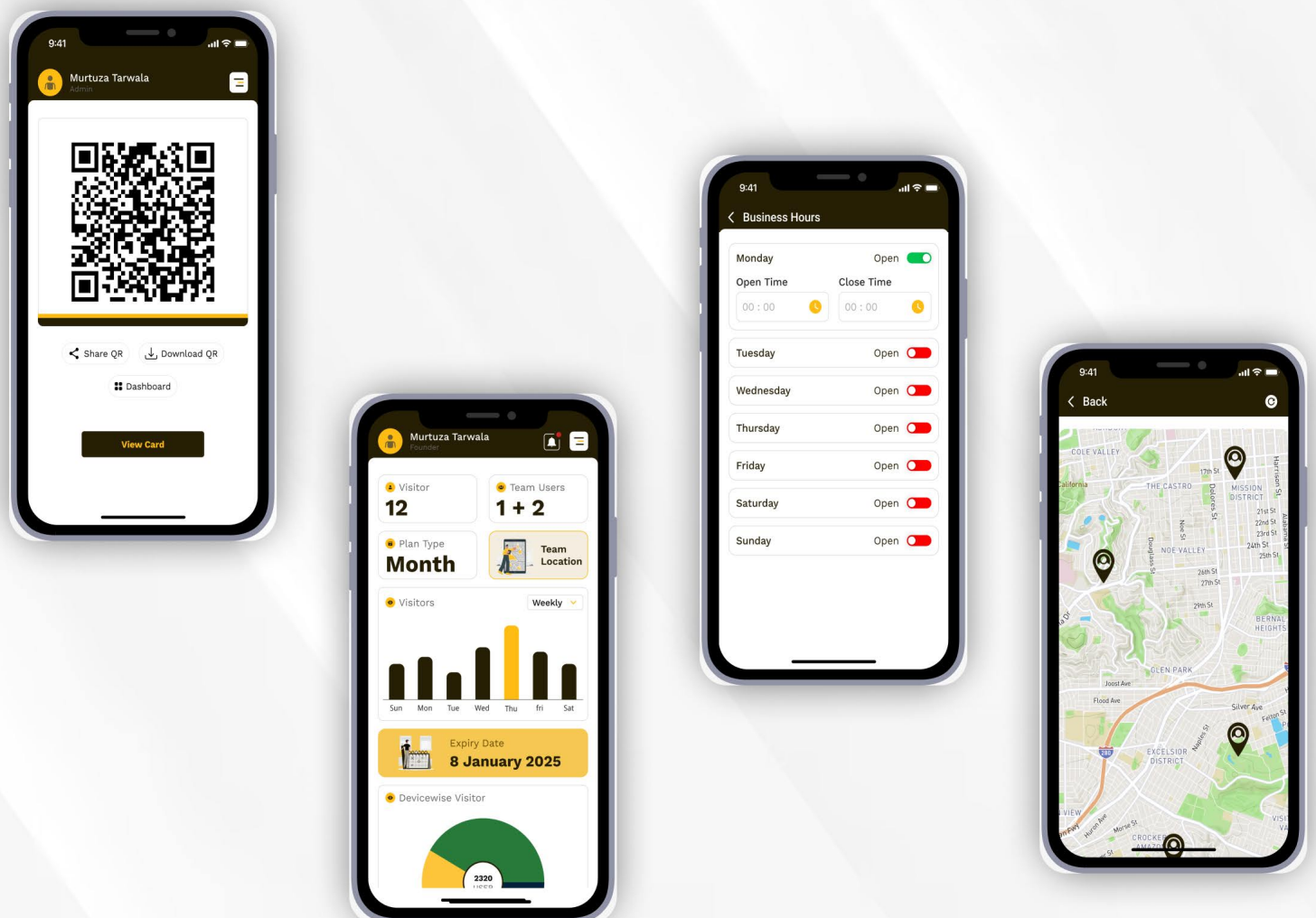

Rain Water Harvesting (Dashboard, Website & Mobile App)

Client:

SMC (Surat Municipal Corporation) Resilience Strata Research & Action Forum

Segment :

Rain Weathercast

Key Features:

- **GIS / location based entry:** Real-time location fetch along with photo and area wise survey for Rain water harvesting system installed in societies.

- **Dashboard:** To view area / zone wise RWH systems in realtime updates.

- Android app for field work
- Zone wise dashboard.

- Live Photographs with GPS of RWH system
- Realtime status update

- Mark that location with unique id & GPS location

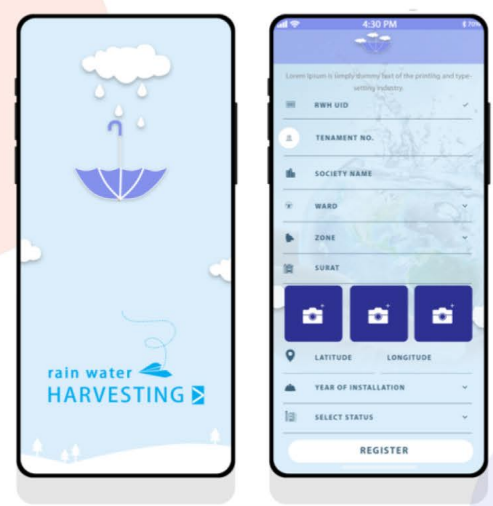
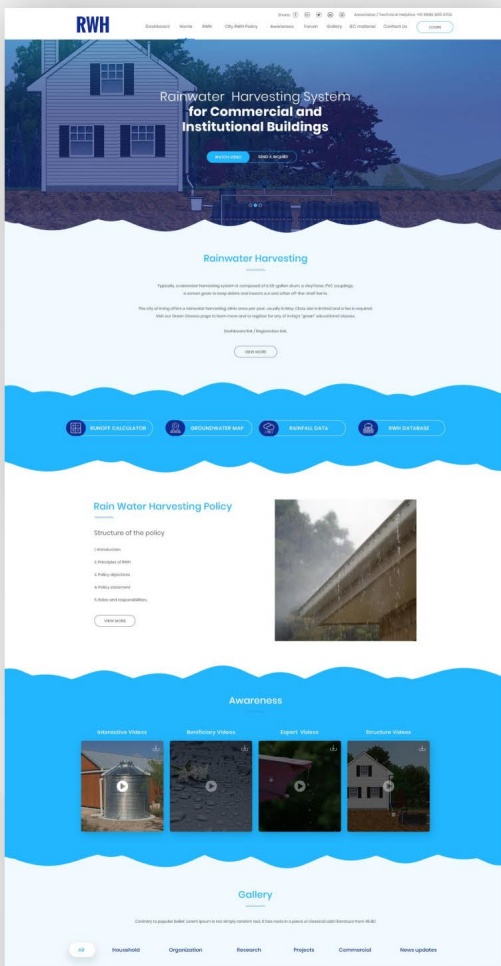

Resilient Surat (Website)

Client:

TARU Leading Edge Pvt. Ltd. / 100RC Surat / Surat Municipal Corporation

The screenshot displays the website's layout. At the top is a navigation menu with links: HOME, ABOUT, COMMITTEE, 100RC TEAM, EVENTS, GALLERY, BLOGS, DOWNLOADS, USEFUL LINKS, CONTACT. The hero section features an aerial view of Surat with the 'RESILIENT SURAT' logo and the text 'SURAT'S RESILIENCE CHALLENGE'. Below this is a 'NEWS / UPDATES' section. The main content area is titled 'DISCOVERY AREA GROUP' and contains six cards, each with an icon, a title, a brief description, and a 'Read More' button:

- Connectivity & Mobility:** The city of Surat suffers from lack of enforcement of the traffic management system...
- Affordable Housing:** The fact that the growth rate of slum population has always been higher than that of the city....
- Water Availability & Quality:** In view of the rising population over the next two decades, to meet the water needs of Surat city..
- Dominant Sectors of Employment & Economic Dependence:** The economy of Surat is heavily dependent on two dominant sectors, which are diamond and textile...
- Eco-system & Environmental Regulations:** The environmental cell should be active and efficient in monitoring air pollution...
- Social Cohesion:** Communities are stable in Surat, but not connected well...

Below the discovery area is a 'BECOME A VOLUNTEER' section with a 'REGISTER' button. A video player shows 'Surat's Resilience Challenge - 100 Resilient Cities'. To the right, the 'RESILIENCE CHALLENGES' section lists:

- ⊙ FLOODING (COASTAL AND RAINFALL)
- ⊙ Unprecedented population growth • High migration • Lack of affordable houses for urban poor
- ⊙ • High dependency on Ukai dam • No alternative source of water • River Tapi catchment management
- ⊙ • Imbalance in diamond business due to growing market of synthetic diamond
- ⊙ • Pollution, especially of water and air • Coastal environment and salinity issues
- ⊙ • Non-availability of migrant records • Community unrest: Reservation issues • Depletion of cultural values



Disaster Management App (Proposed Concept For Mobile App)

Client:

TARU Leading Edge Pvt. Ltd. / Surat Municipal Corporation

Key Features:

- **Alert System:** Real-time alerts for Weather, Traffic, Tide & Forecast.
- **Area Based Alerts:** Alerts based on their current location or can add multiple location in setting to get updates for other areas.

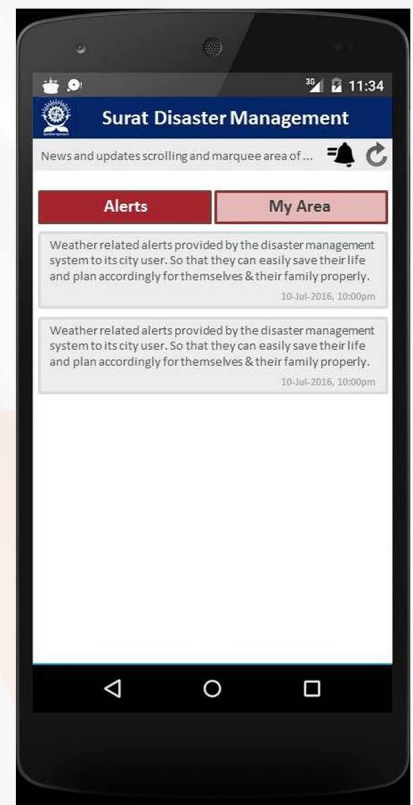
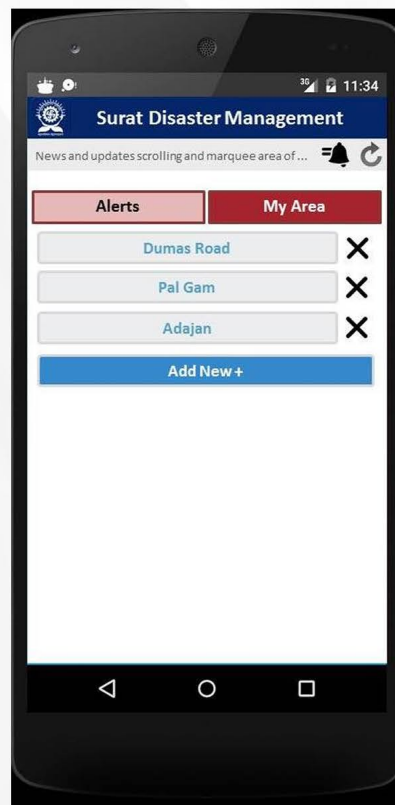
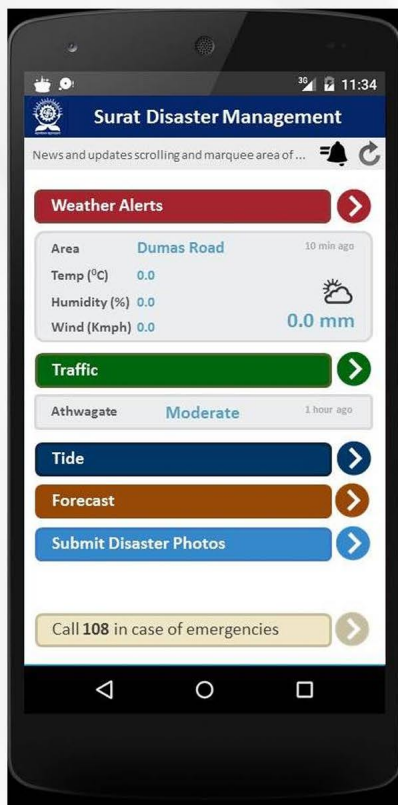

DAT - Damage Assessment Tool (Web App , Mobile App)

We proudly collaborated with DAT, an initiative associated with UNICEF, to create an innovative damage assessment app. This app revolutionizes the way disaster impacts are assessed and enables DAT to efficiently gather crucial data for humanitarian aid and relief efforts.

Client:

Govt. of Bihar, Unicef

Key Features:

- Dashboard for display category wise stats
- Template form for all categories.
- Form filled by team, then it needs to be approved by higher authority, till then it remains in draft mode.

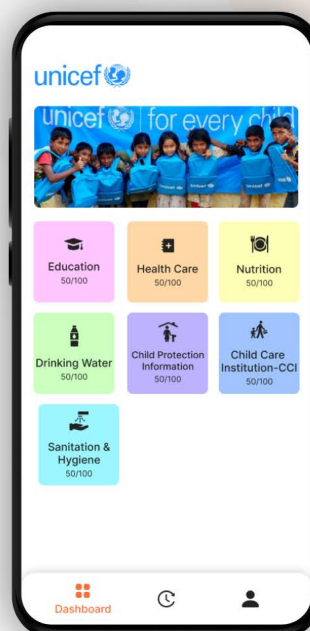
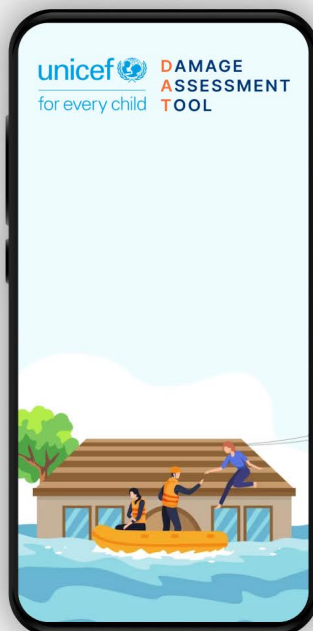
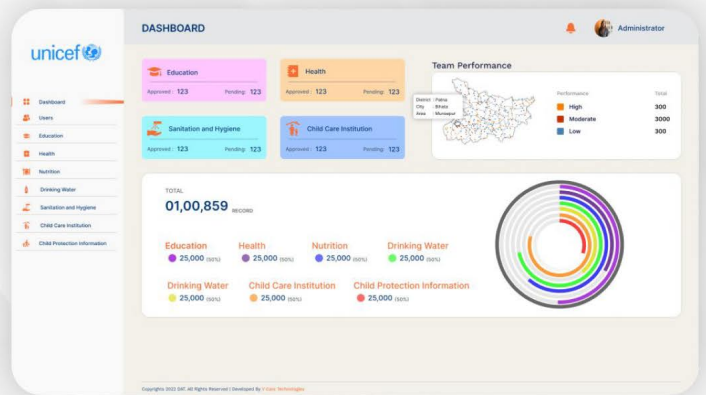

DhawaDal (Web App , Mobile App)

Client:

Govt. of Bihar, Unicef

Segment :

Child Rescue Survey

- A one-of-its kind mobile application and Web Tool with multiple reporting interventions and GIS mapping to give real-time feedback to the Ministry of Labor about rescuing under-aged children from factories where they are forced to work.
- This application serve also as hierarchy control mechanism with access given only to authenticated users.
- The application also serves as a repository to trace the development in each case and the progression of the case.
- Data security measures such as editing of data is only provided to users after prior permission of the supervisors.

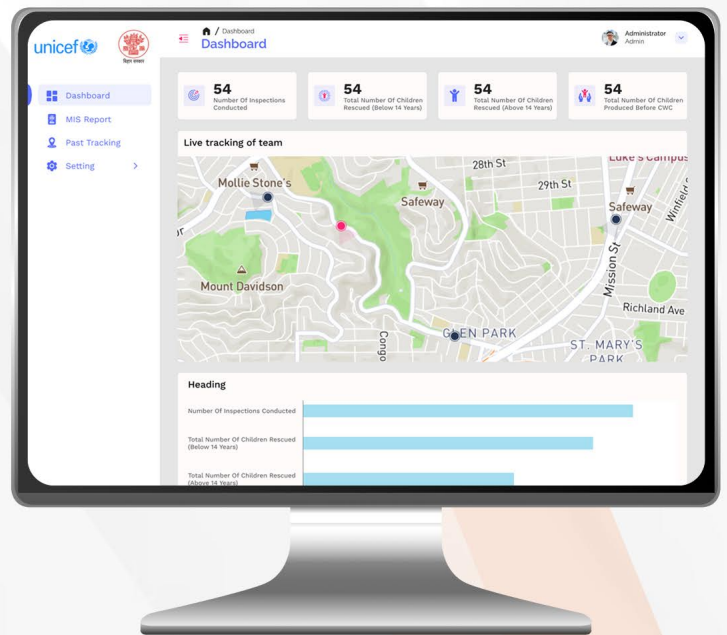
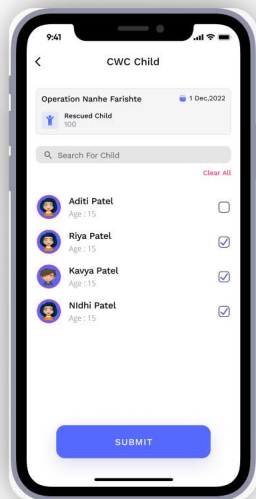
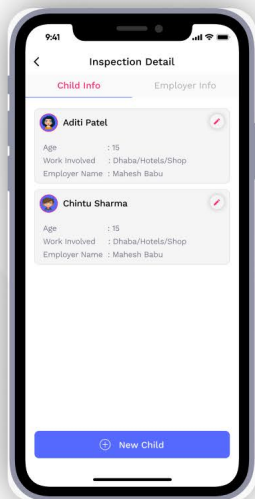
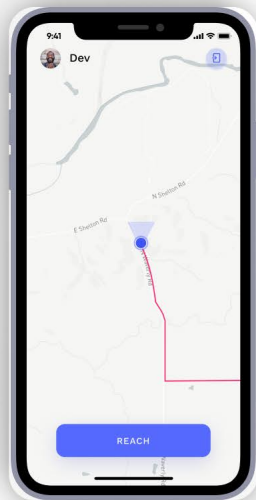
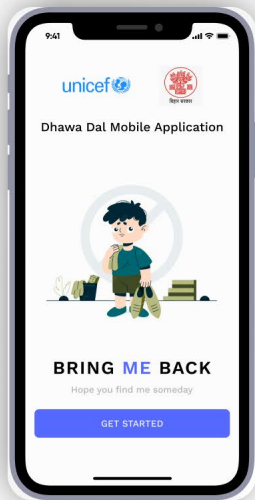

Mapann (Mobile App)

Segment :

Healthcare

Challenge:

Larger hospitals often face challenges in managing patient flow, providing clear navigation for patients and visitors, and ensuring efficient doctor-patient interactions.

Solution:

Mobile App that provides a comprehensive solution for larger hospitals, addressing the challenges of patient navigation, doctor-patient interaction management, and ensuring app usage restriction within hospital premises.

Key Features:

- **Indoor Navigation:** Real-time indoor navigation guides patients and visitors to their desired destinations within the hospital, eliminating confusion and reducing wait times.
- **Patient Flow Management:** Doctors receive real-time updates on patient arrivals and estimated consultation times, allowing them to plan their schedules effectively and optimize patient flow.
- **Geofencing:** The app's functionality is restricted to within the hospital premises using geofencing technology, ensuring that it is only accessible to patients, visitors, and authorized hospital personnel.

Users

- **Patients:** Easily navigate the hospital using indoor navigation and find their desired destinations.
- **Visitors:** Locate patient rooms, departments, and other hospital facilities using the app's navigation features.
- **Doctors:** Receive real-time updates on patient arrivals and estimated consultation times to manage their schedules effectively.
- **Hospital Staff:** Enter data easily and use it for navigation.

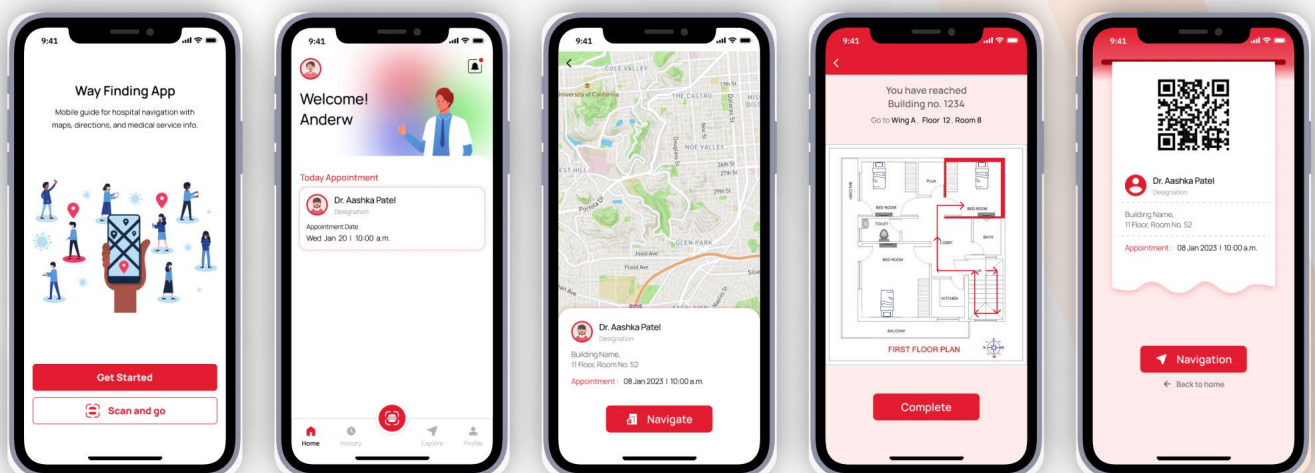



WHO - GIDM (Web App - Ongoing)

V Care Technologies has developed a web app for disaster preparedness that provides early warning alerts and information about disaster-prone areas, as well as a DM plan for hospitals, HRVC tool, risk matrix, radio tool, live chatting, and audio exchange features.

Client:

Govt. of Bihar, Unicef

DM plan for hospitals :

- The web app provides a customizable DM plan for hospitals, helping them to develop and implement a comprehensive plan for preparing for, responding to, and recovering from disasters.
- It includes a risk matrix that helps hospitals to identify and assess the risks posed by different types of disasters.



GUJARAT Hospital Name: Admin

3. Staffing

No. of Doctors:

No. of Non-Teaching Paramedic Staff:

No. of Nursing Staff:

Management Staff:

Board of Directors: Name of the President/Director:

Contact Details

Designation	Telephone	Mobile	Fax	Email
Doctor	0723456789	8876543210	0723456789	john.doe@myhospital.com

Previous Save Next

GUJARAT Hospital Name: Admin

2. Infrastructure

Date of Construction of Hospital Resident Building: Type of construction/ structure of building:

Retrofitting has been Done: Yes No

Number of Departments:

Total number of wards:

Number of Beds:

Number of Surgical Laboratories: Number of Biochemical Laboratories: Number of Radiological Laboratories:

OPD/Emergency Timings: Day shift Night shift

Previous Save Next

Hazard Map :

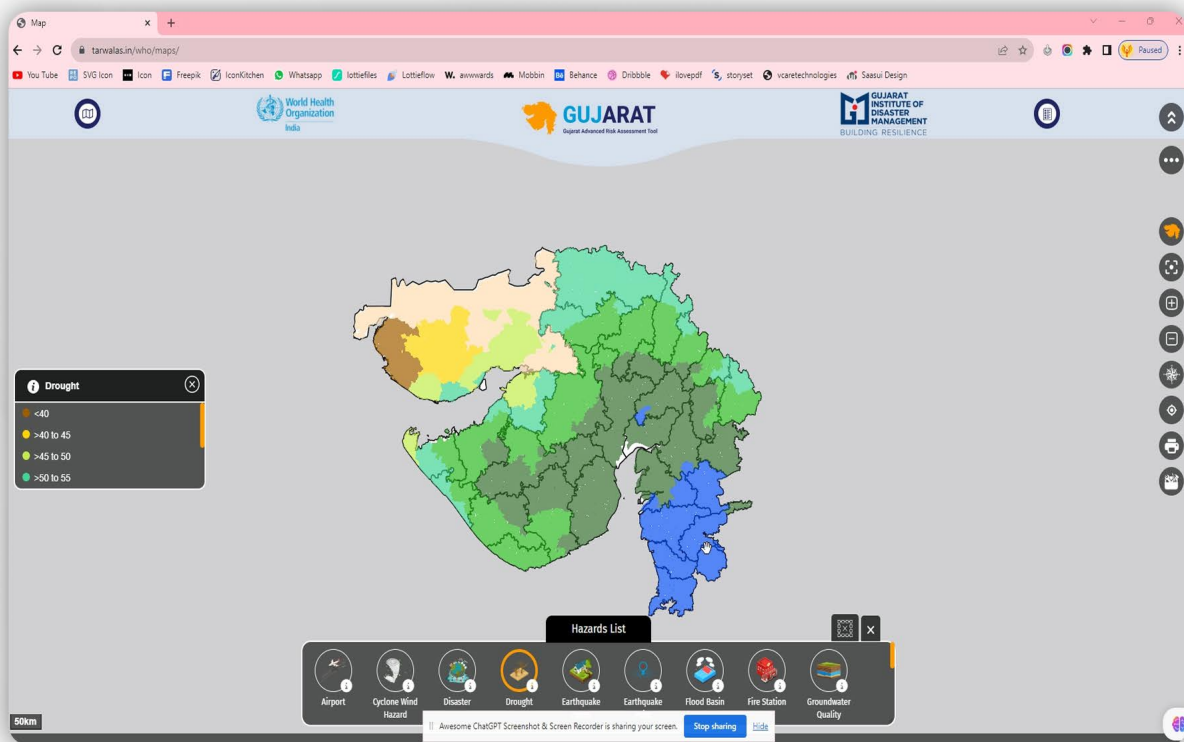

Radio Tool :

The web app includes a radio tool that allows hospitals to communicate with each other and with emergency responders during disasters.



HRVC Tool :

The web app includes a Human Resource Vulnerability and Capacity (HRVC) tool that helps hospitals to assess their HR vulnerabilities and capacities, and to develop plans to address any gaps.

 World Health Organization

Home / Facility / Facility Risk Matrix / Incident Response System Organogram

Facility

Name of Facility

Location



Assessor Detail

Name of Assessor <input type="text" value="Enter Name of Assessor"/>	Group Name <input type="text" value="N/A"/>	Date <input type="text" value="03/22/2024"/>	Time <input type="text" value="02:59 PM"/>
Mobile No. of Assessor <input type="text" value="Enter mobile number"/>	Designation <input type="text" value="Enter your Designation"/>		

Hazard Hunt Exercise

Hazard hunt exercise is a survey of facility to identify potential hazards in the existing facility to identify the hazard and assess risks to guide actions, inform planning and provide evidence to strategies and policies for better prevention, preparedness, response and recovery, which are critical for emergencies and disasters. User may upload the image/video of issues identified during the facility survey, accompanied by detailed descriptions in this section.

Upload Image/Video

Area/ Floor/ Room

Issue

Type of Issue

Impact

Solution Type

Immediate	<input type="text" value="Type here..."/>
Medium term	<input type="text" value="Type here..."/>
Long term	<input type="text" value="Type here..."/>

Global Covenant Of Mayors (Website & Maintenance)

Client:

Global Covenant of Mayors – South Asia

Key Features:

- **Managing India Site:** Managing India website in regional language.
- **City Pairings:** Pairing the Indian city with international city database.

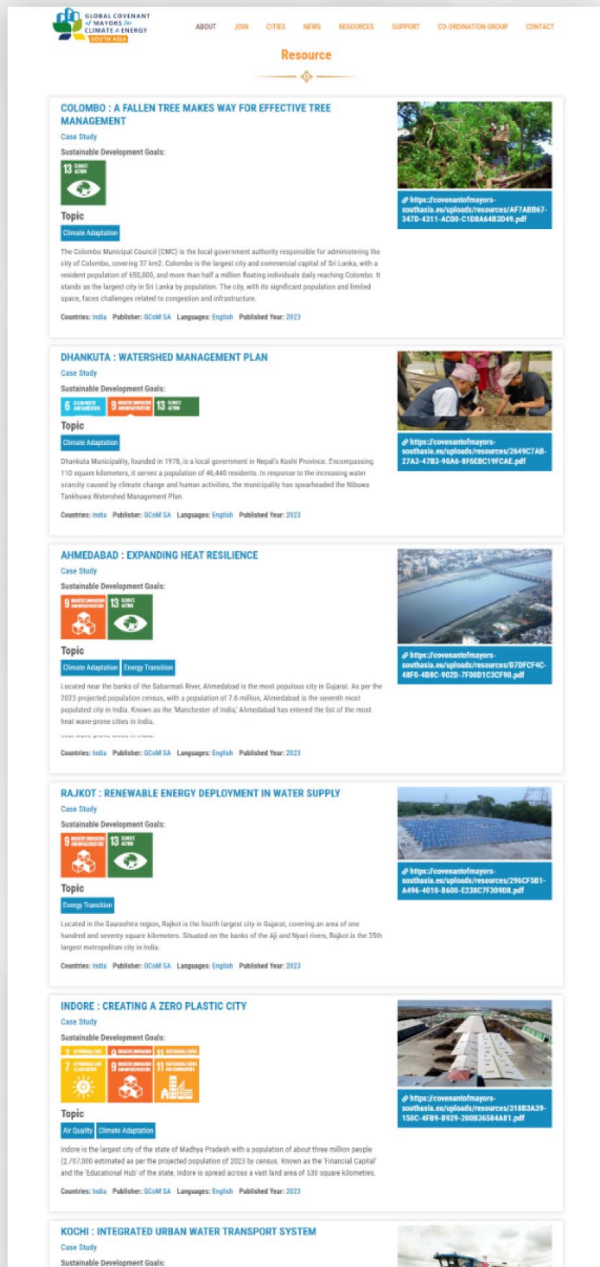

IUC (Website & Maintenance)

Client:

International Urban Cooperation - European Union

Key Features:

- **Managing India Site:** Managing India website in regional language.
- **City Pairings:** Pairing the Indian city with international city database.





My Cash Coupon (Website & Mobile App)

Client:
Astevis Pharma

Segment :
Pharmaceutical Industry

Key Features:

- Earn Points/Coins- Get Reward in form of coins.
- Redeem coupons/vouchers.
- Affiliate Programming.
- Eligibility Verification.

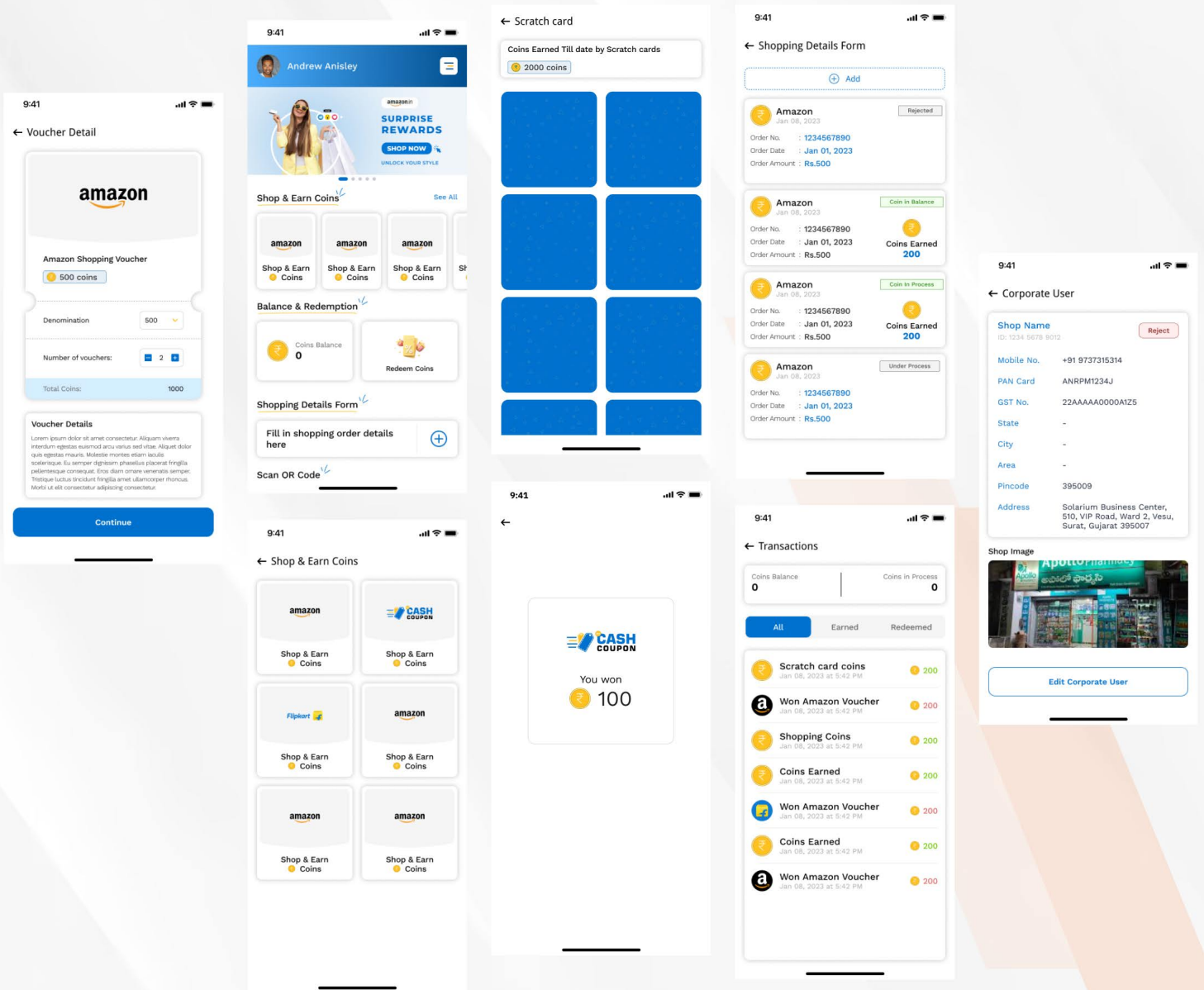



Breval (Mobile App)

Our SaaS platform helps businesses efficiently manage assets, checklists, schedules, and compliance tasks. Company owners or directors can register, select plans, and add team members using a unique company code. Teams can then access and manage Red Tags, Assets, Checklists, and Schedules, with the ability to generate and export compliance certificates.

Client:

Breval Consulting LLP

Segment :

Saas Product

Key Features:

- **Company Registration & Plan Management:** Register your company, select plans, and manage features like Red Tags, Assets, and Checklists.
- **Red Tag & Asset Tracking:** Flag critical items with Red Tags and track asset status, location, and condition.
- **Checklist & Scheduler Tools:** Create custom checklists and schedules, set reminders, and track task completion.
- **Team Access & Collaboration:** Team members register via company code and access tools.
- **Export Certificates:** Generate and export compliance certificates.
- **Real-Time Notifications:** Get instant updates on task progress and changes.

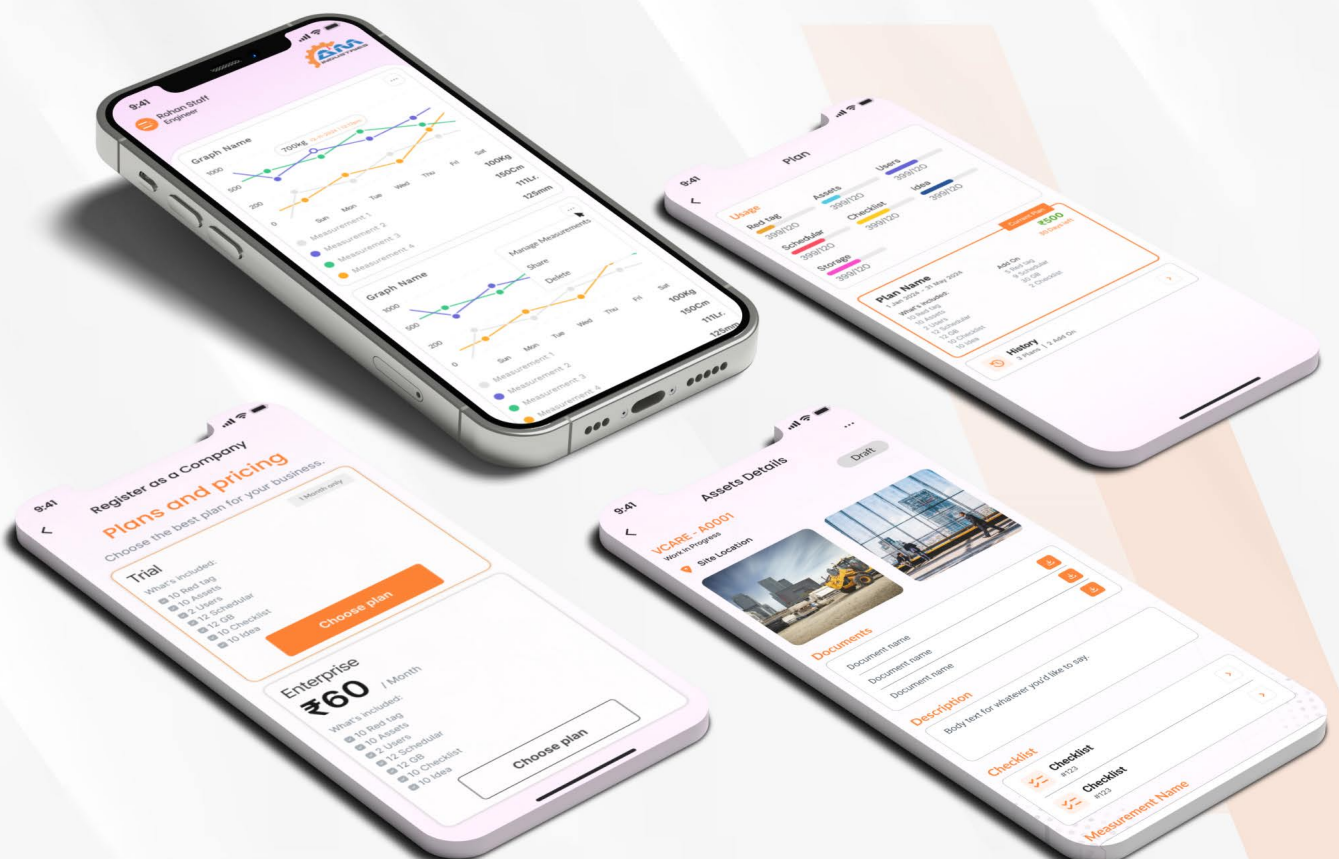

Certificates



Mantra (Website & Testing Laboratory Software)

Introducing a cutting-edge software solution designed to streamline the testing and approval process for textiles in manufacturing laboratories. Developed with the needs of mantra textiles in mind, that revolutionizes quality assurance practices, ensuring that every product meets the highest standards of performance, durability, and safety.

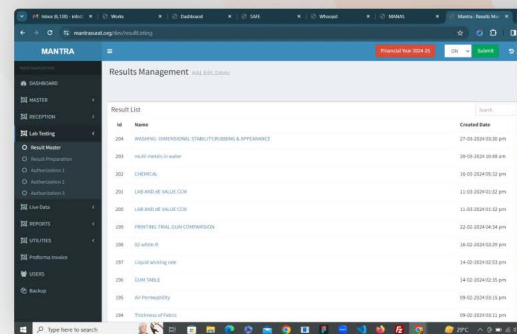
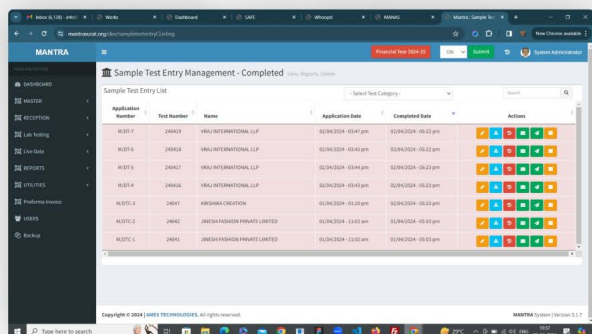
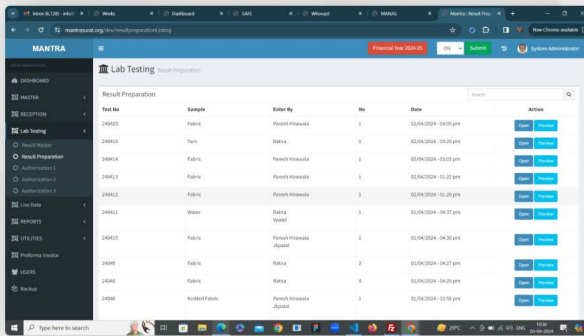
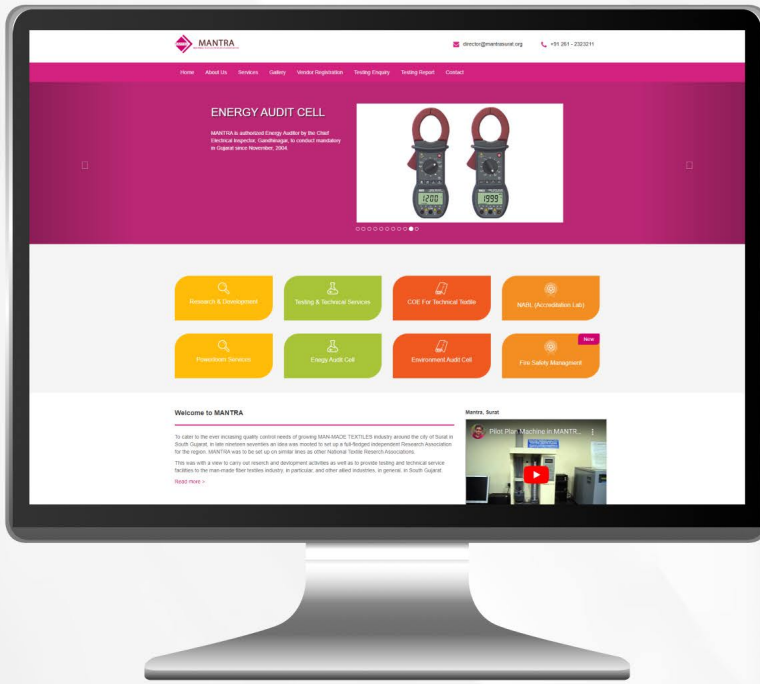

Savani Textiles (Mobile App)

Client:

Mr. Satish Savani

Before

- Traditional Manual process.
- Daily sit with their team of 6-7 department heads around 30min.
- Facing challenges in managing orders and tracking processing orders, etc.

Key Feature :

Process Management App

Success Story :

Now he is funding 1 startup and refer to us for making their mobile apps.

Business :

Textile Industry since 30 years.

After

- With help of mobile apps with user friendly designs. Their process operations efficiency increased.
- Saving approx. 14days of salary of department head every month in just 5 months of implementation.

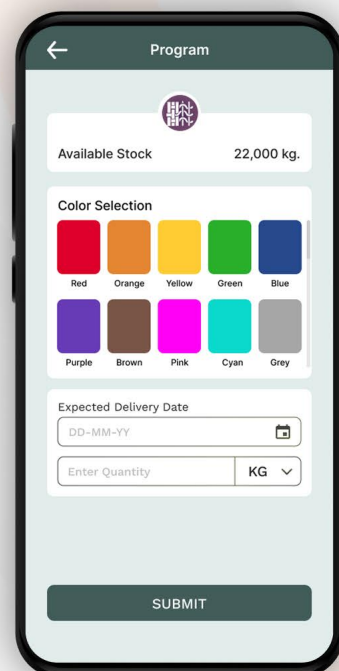
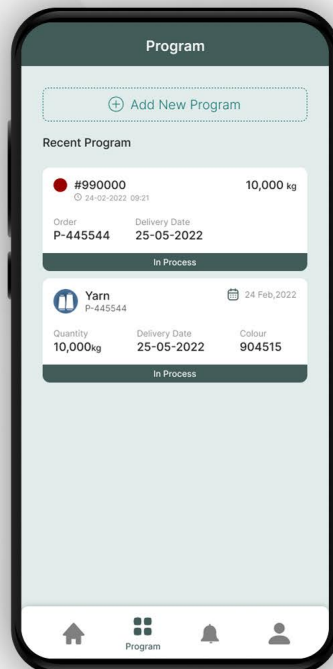
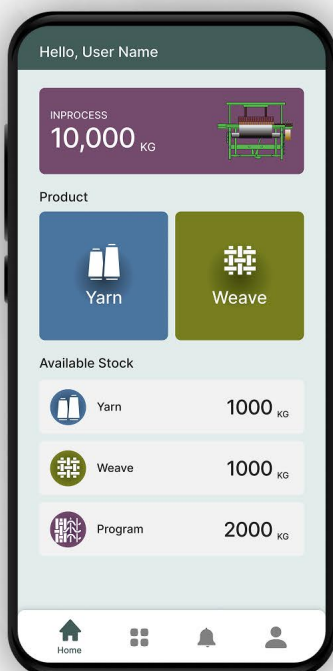



Mira Jewels (Commerce Website)

Client:

Mr. Sunil Patel

Business :

Diamond Manufacturing (Offices across 5 Countries)

Before

- Worked with different web developers.
- Spend more than 3lacs plus within time frame of 1yr.
- Didn't get Support & Speedy work updates as and when required.

After

- Required an E-commerce platform with price changing according to gold carats and rates.
- We created site named Joyari.
- Funtionality – price change dynamically, logistics, etc. within 4 months and till date we have successfully build and maintained his 4 other projects named -Bebaby Bridal, Stunning Jewelry, Treasta, NitiStar apart from Joyari .

Success Story :

Currently 2 other projects are in pipeline.



Joyari (Website)

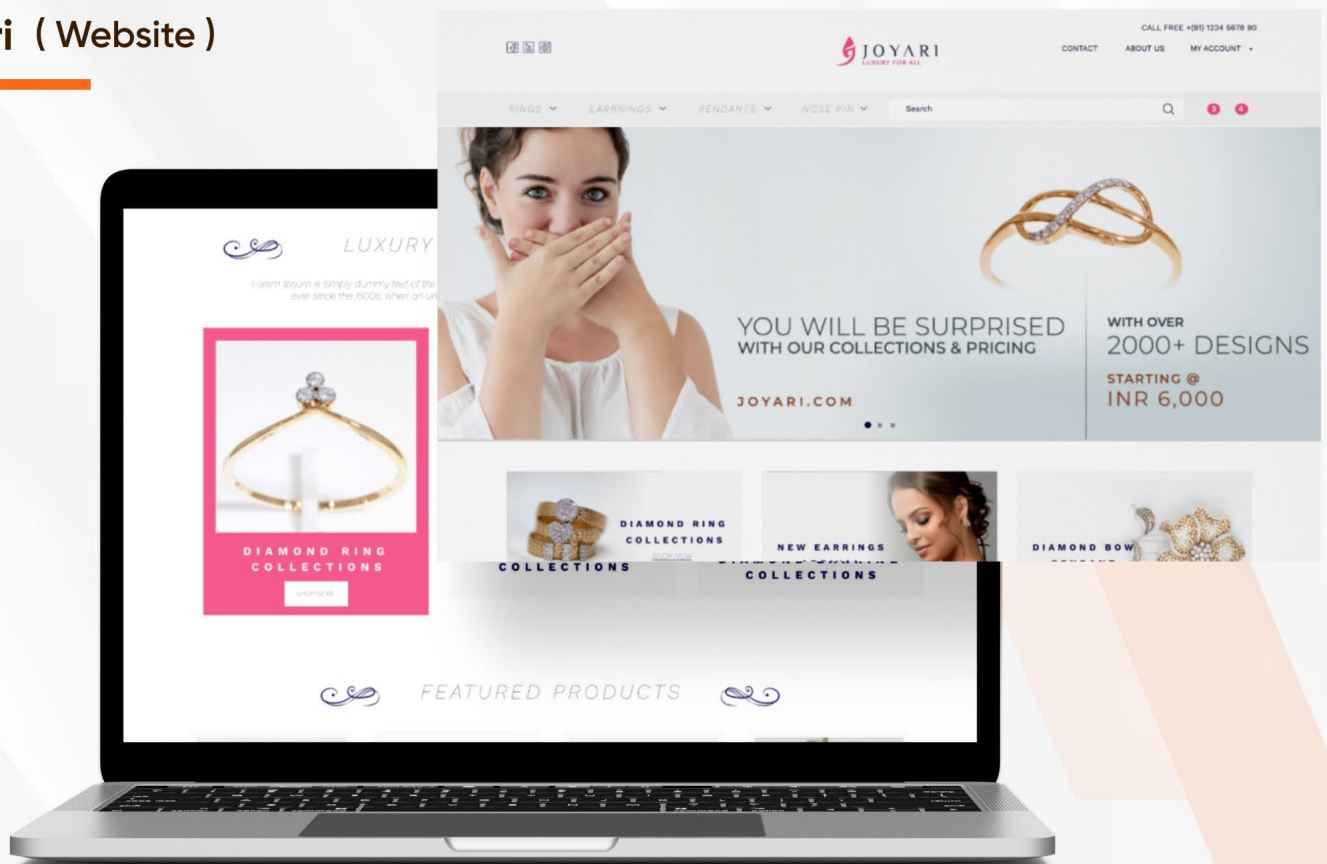

Stunning Jewelry (Website)



Be Baby Bridal (Website)



Veriyog International (Web App)

Client:

Mr. Manish Nandale

Business :

RO service industry

Before

- A successful businessman who works morning 9:00am till 10:00pm.
- He is earning handsome amount of money but he was not able to figure out the time for his family.
- Facing issues in finding service renewals of his customers, AMC service, visit's scheduling for his team, calculating the stock, managing his orders based on MOQ, etc.

After

- He met me in BNI KARMA in 2022 and we gave the solution,
- He compared our proposal and services with other vendors.
- Today's Result - he is closing his office at 7:00pm and saves his minimum 3 hrs daily and his team gets their service data automatically.

Key Feature :

Task Automation Dashboard

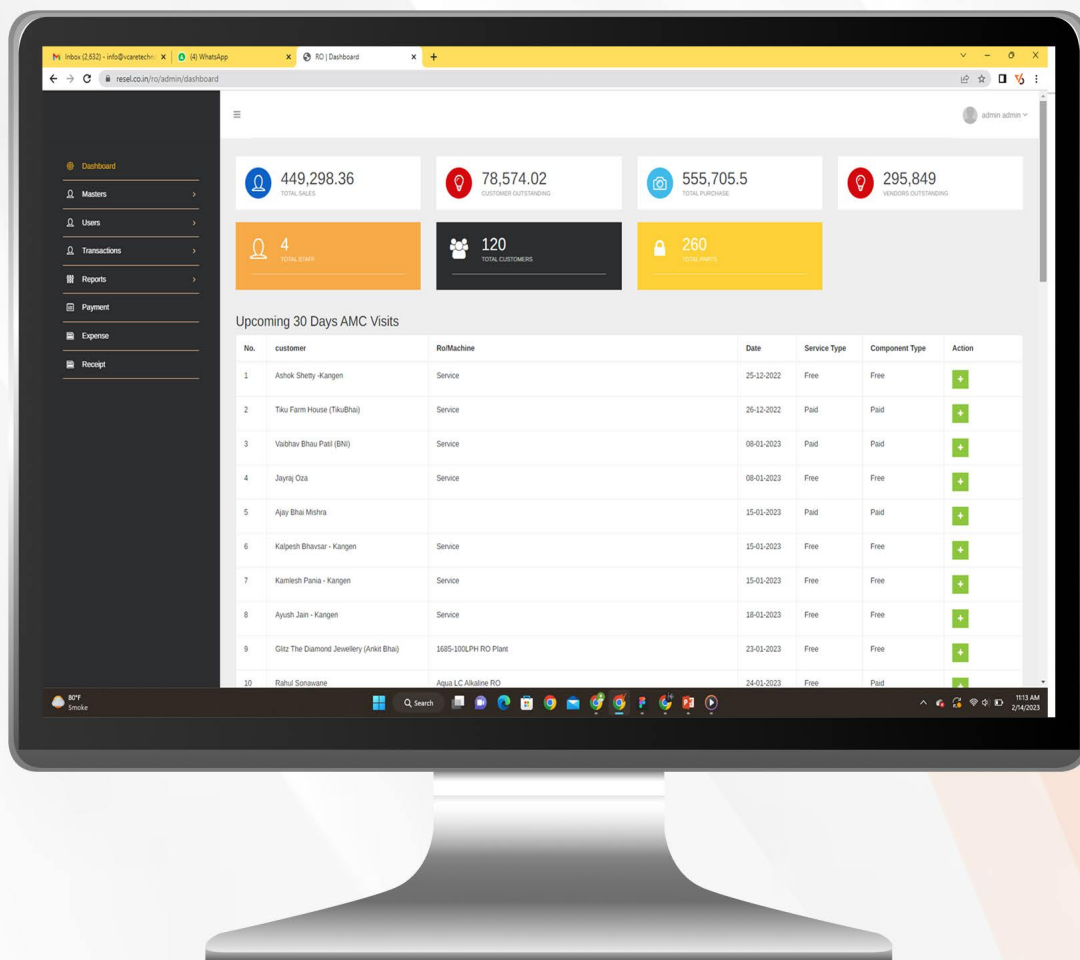

Medical Service Manager (MSM) (UX/UI)

Segment

Medical

Problem

A company launching a web app as a product for doctors to record data of patients such as Name, contact details, emergency contact, patient history, mediclaim details,etc. was looking for some professional experts who can design such User Friendly web portal.

Solution

Our team designed a user-friendly and efficient web app UI/UX for a doctor's patient record management system. The app allows doctors to easily record, update, and access patient data, including name, contact details, emergency contact, patient history, mediclaim details, and other relevant information. The app features a clean and intuitive UI that makes it easy for doctors to navigate and find the information they need quickly.



Writeway (Mobile App , Web App)

Segment

E-Commerce

Key Feature :

- **Centralized Admin Panel:** A single admin panel manages both the e-commerce website and mobile app, streamlining operations
- **Real-time Product Sync:** Product updates made in the admin panel are instantly reflected on both the website and mobile app, ensuring consistency.
- **Customer Data Consolidation:** Customer data is consolidated across both platforms, providing a unified view of customer interactions.
- **Order Management:** Orders from both the website and mobile app are managed in a single location, simplifying order fulfillment.

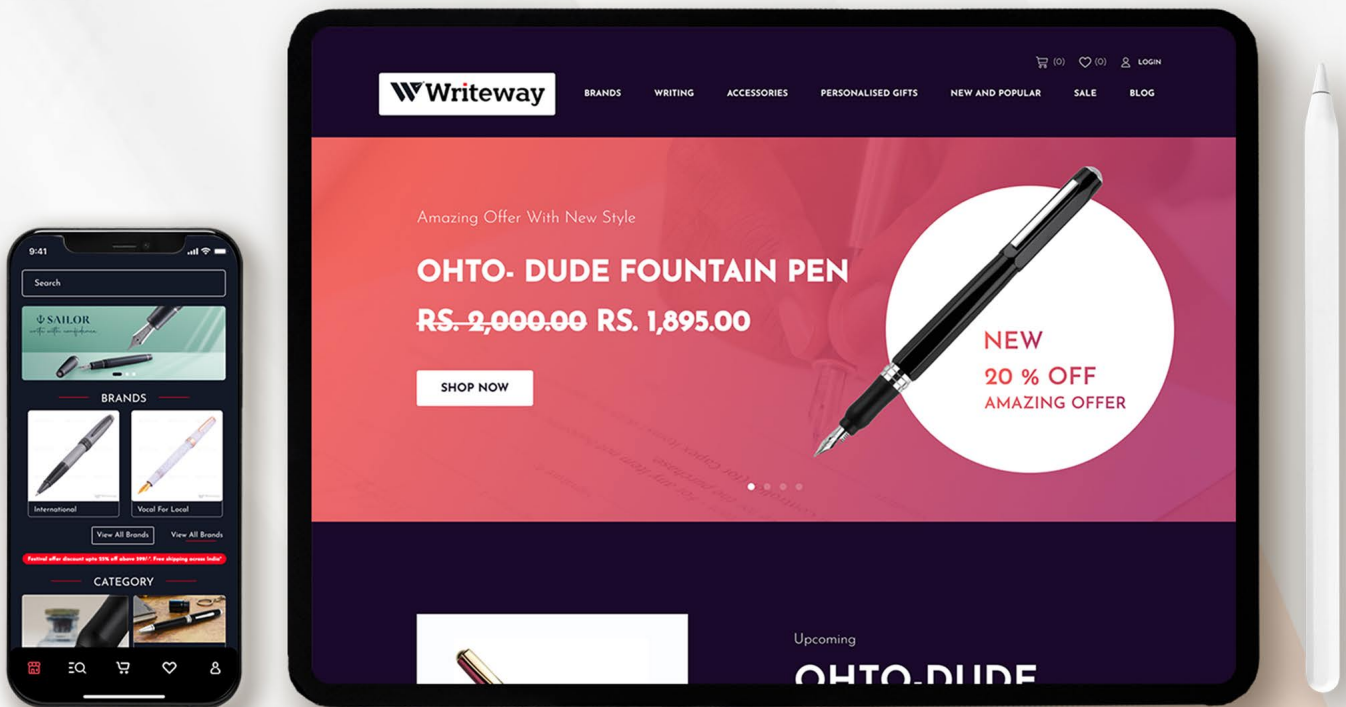



Sunshine Lights (Web & Mobile App)

Problem:

Traditional methods of preparing quotations were time-consuming, utilized resources, error-prone, and inconvenient. Salespeople often lack access to product information, pricing data, and quotation templates while interacting with customers at showrooms, during telephonic inquiries, or on sales calls.

This App streamlines the quotation generation process, enabling salespeople to create professional and accurate quotations in minutes, anytime, anywhere.

Key Feature :

- **Seamless Product Selection:** Easily browse and select products from a comprehensive catalog, including detailed product information and images.
- **Real-time Pricing Calculations:** Access up-to-date pricing information, including discounts.
- **Automated Quotation Generation:** Generate professional quotations with a single click, incorporating selected products, pricing and customer details.
- **On-the-Spot Delivery:** Share quotations instantly via email, whatsapp or any preferred communication channel.

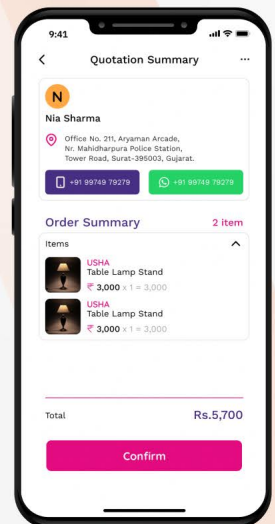
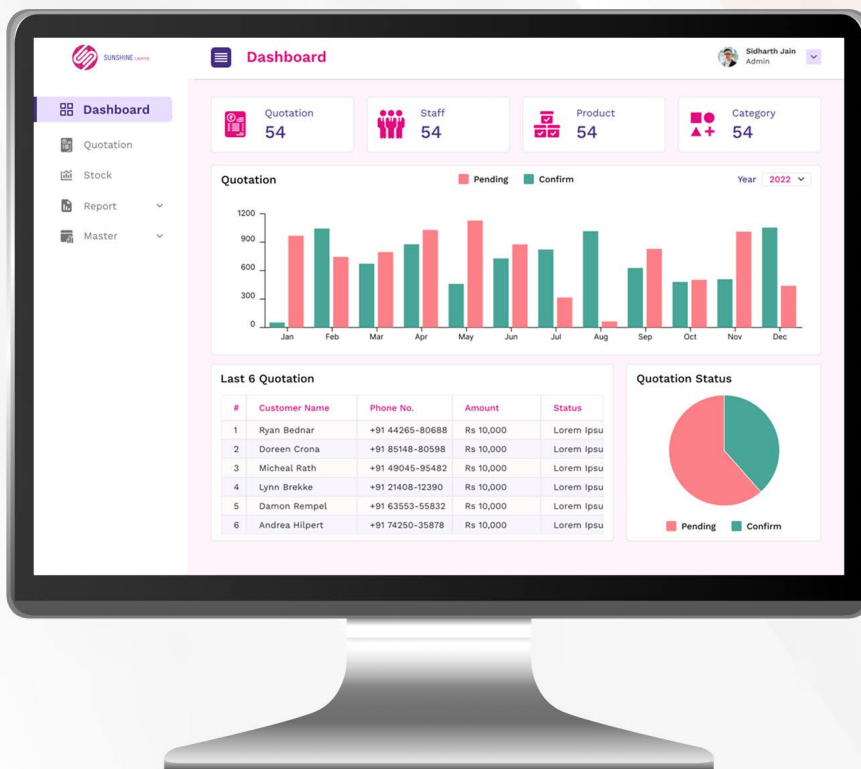



JARIWALA ENTERPRISES JARIWALA SALES PVT. LTD.

Jariwala Enterprise (Mobile App)

Client:

Jariwala Enterprise

Segment :

Distributor of Apple Products (South Gujarat)

Problem:

- Distributors major time spent over call managing stock data and communicating with various dealers.
- Dealers and distributors often didn't have the latest information about what's in stock. This was leading to stockouts or overstocking.
- Placing and tracking orders manually was a slow process. This led to delayed orders and made customers unhappy.
- Without up-to-date sales data, it was hard for dealers and distributors to figure out how to make more money.

Solution:

We delivered a Mobile App that streamlines communication and collaboration between dealers, distributors, and the sales team. The app provides real-time access to inventory levels, sales performance data, and order history, enabling informed decision-making and improved efficiency.

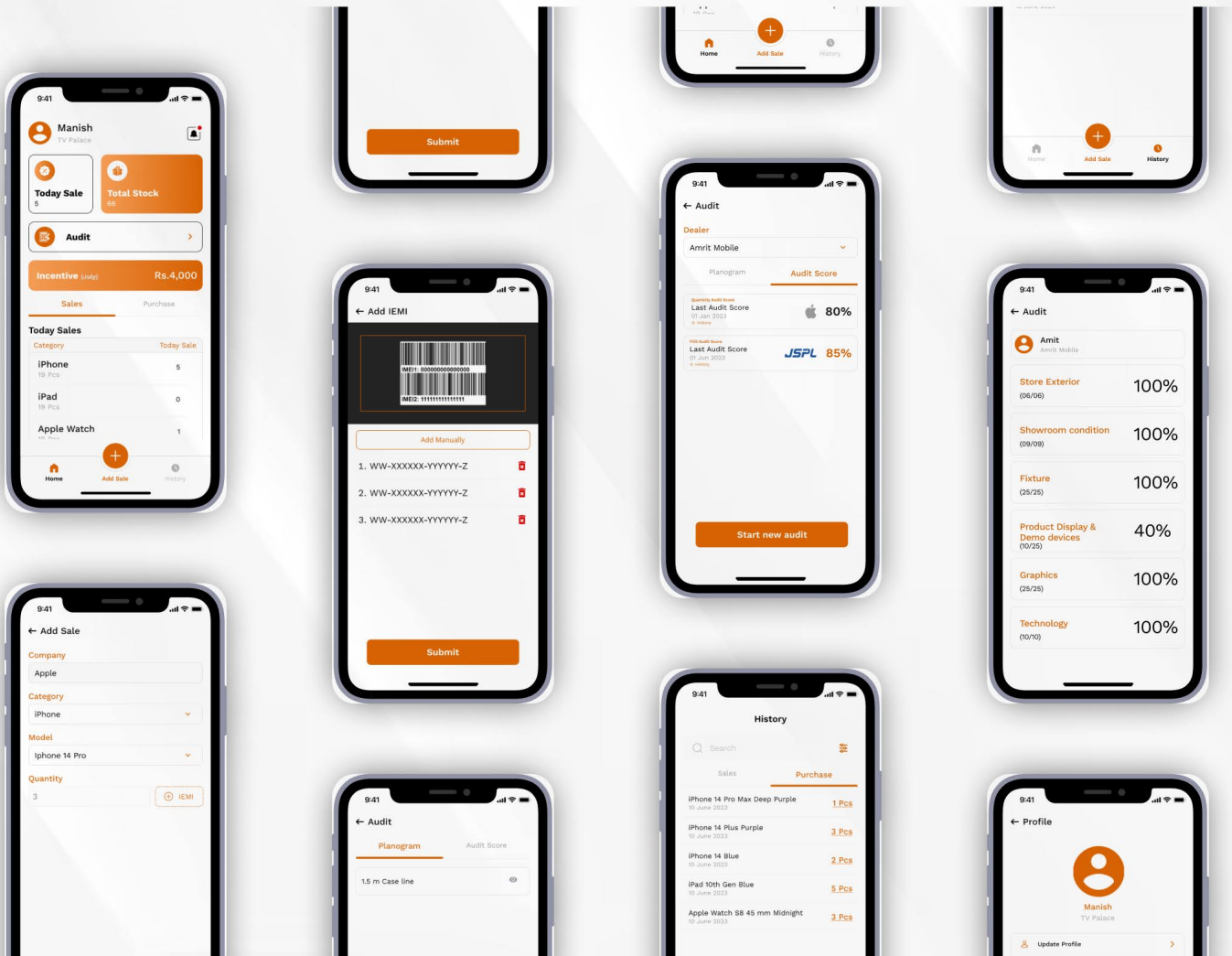

Key Features:

- **Real-time Inventory Management:** Dealers and distributors can view real-time available stock levels for all products, ensuring they always have the right products on hand to meet customer demand..
- **Audit Report Access:** he sales team can easily access audit reports to track dealer performance, identify areas for improvement, and provide targeted support.
- **Order Placement and Tracking:** Dealers can seamlessly place orders to distributors directly through the app, and track order status in real time.

Users:

- **Dealers:** View real-time inventory levels, place orders, and track sales performance.
- **Distributor:** Manage inventory levels, process orders, and track dealer performance.
- **Sales Team:** Access audit reports, provide support to dealers, and monitor overall sales performance.

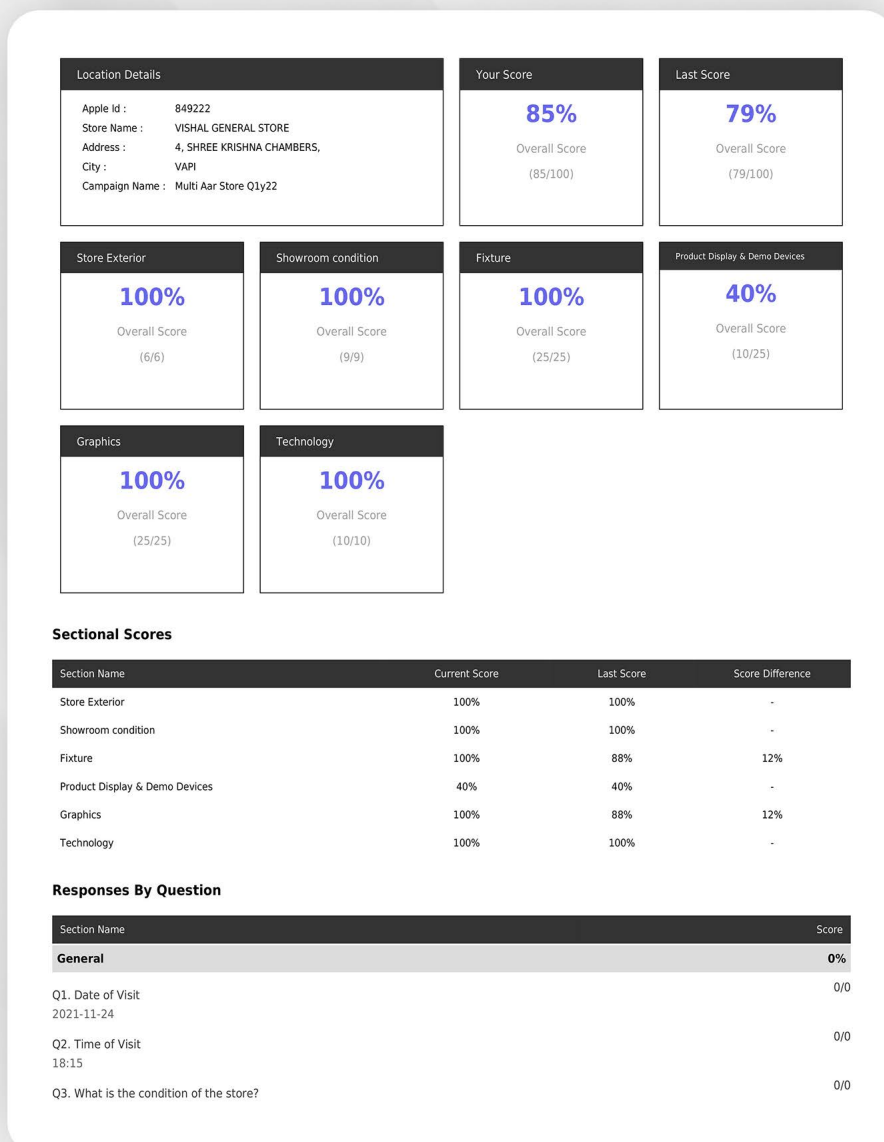



Yugarambh (Web App)

Client:

Tulsyam Fashion

Segment:

Kurta Wholesale Dealer

Problem:

They are manufacturers of Men's Ethnic Wear selling their products across various online platforms such as Amazon, Flipkart, Meesho, etc. In this situation they are unable to get data of returned products, hence lack clarity of exact profit made.

Solution:

We created a web app where an unique barcode is generated for every product and with that they can get data of stock and show the report of total orders and out of that how many orders were returned.

Key Features:

- **Barcode Generation:** Automatically generates unique barcodes for each product, facilitating easy identification and tracking.
- **Inventory Management:** Real-time inventory tracking keeps manufacturers informed of stock levels, preventing stockouts and overstocking.
- **Multi-Platform Order Tracking:** Consolidates orders from various platforms like Amazon, Flipkart, and Meesho into a single system, providing a centralized view of all orders.
- **Sales Reporting:** Generates detailed sales reports that include total orders, returned orders, and sales trends, enabling informed decision-making.

#	Barcode	Photo	Product Name	Size	Price	Quantity
1			1008 - Jacquard Kurta	S	Rs.1,500	12
2			1009 - Men's Gems Kurta	L	Rs.1,500	0
3			1010 - Floral Print in Men's Kurta	M	Rs.1,500	0
4			1011 - Geometrical Prints in Men's Kurta	XL	Rs.1,500	64
5			1012 - Men's Short kurta	XXL	Rs.1,500	34
6			1013 - Men's kurta without collar	3XL	Rs.1,500	76
7			1014 - Men's kurta with koti	4XL	Rs.1,500	46
8			1015 - Chikankari Men's Kurta	5XL	Rs.1,500	96
9			1016 - Lucknowi Chikankari Men's Kurta	XL	Rs.1,500	34
10			1017 - Kurta Pajama	M	Rs.1,500	45

Tulsyan Textile (Mobile App)

The mobile app streamlines field operations for sales and customer service teams by simplifying attendance tracking, visit logging, lead management, catalog sharing, and order placement. It also stores detailed histories and provides attendance summary reports, improving workforce management. This all-in-one platform enhances productivity, communication, and decision-making, driving better sales performance and customer satisfaction.

Key Features:

- **Attendance Tracking:** Seamlessly check-in and track attendance for staff.
- **Visit Logging:** Record detailed information about each client visit, including notes, actions, and follow-ups.
- **Follow-Up Management:** Set reminders and track follow-ups to ensure timely and efficient customer engagement.
- **Catalog Sharing:** Instantly share product catalogs and brochures with clients during visits.
- **Order Placement:** Place product orders directly through the app during client visits for streamlined sales processing.





Touch switches and Automation

COZA Automation (Web App)

Client:

Tech Comfort Solutions PVT. LTD.

Segment:

Technology

Problem:

Manufacturer of Automated Switches , faced difficulty in creating quotations with many variations and minute details for single customer and track leads. The owner was looking for some expert to create his brand identity.

Solution:

We created stunning website that reflects his brand identity and showcase his products and services. Also we created web based software, with which they can add lead ,follow-up process, then generate multiple quotations very easily and quickly.

Key Features:

- **Lead Management:** Centralizes lead data, enabling efficient follow-ups and conversion into sales opportunities.
- **Quotation Generation:** Generates customized quotations with detailed product descriptions, pricing variations, and pictorial illustrations.
- **Customer Data Storage:** Stores customer information, including contact details, purchase history, and installation records, for easy access and future reference.
- **Order Fulfillment:** Facilitates order tracking and ensures seamless coordination between sales and installation teams.

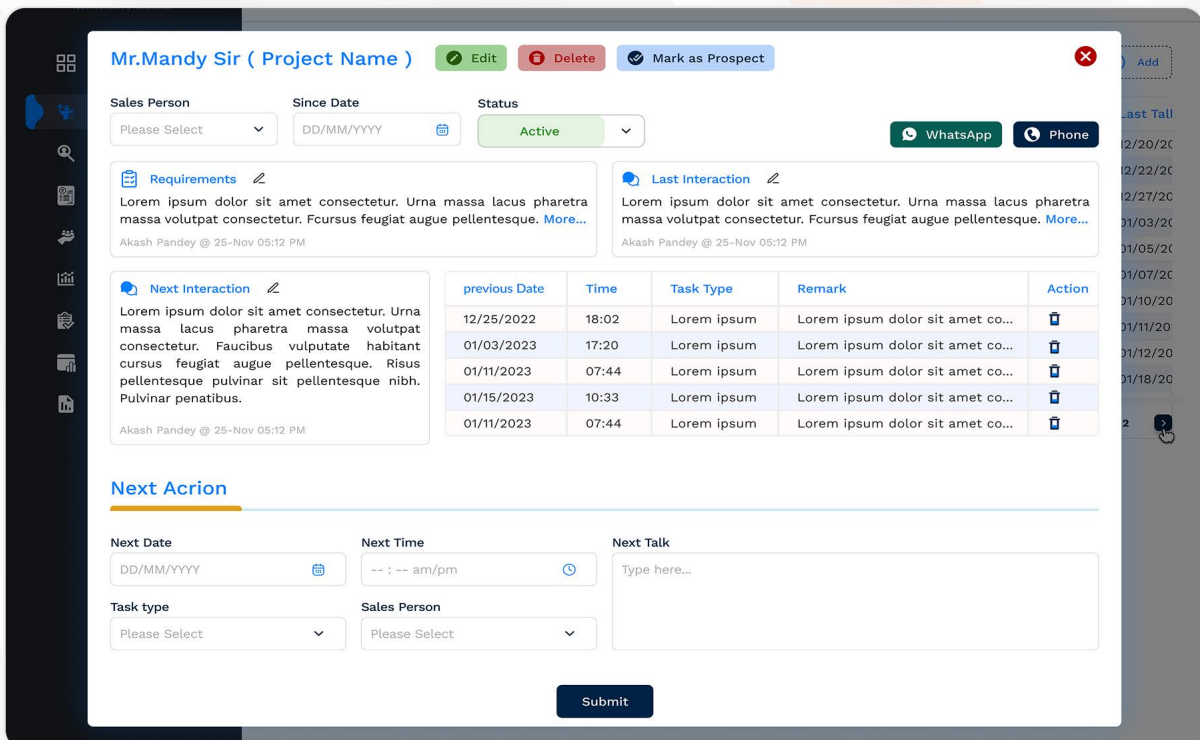

Incentive management:

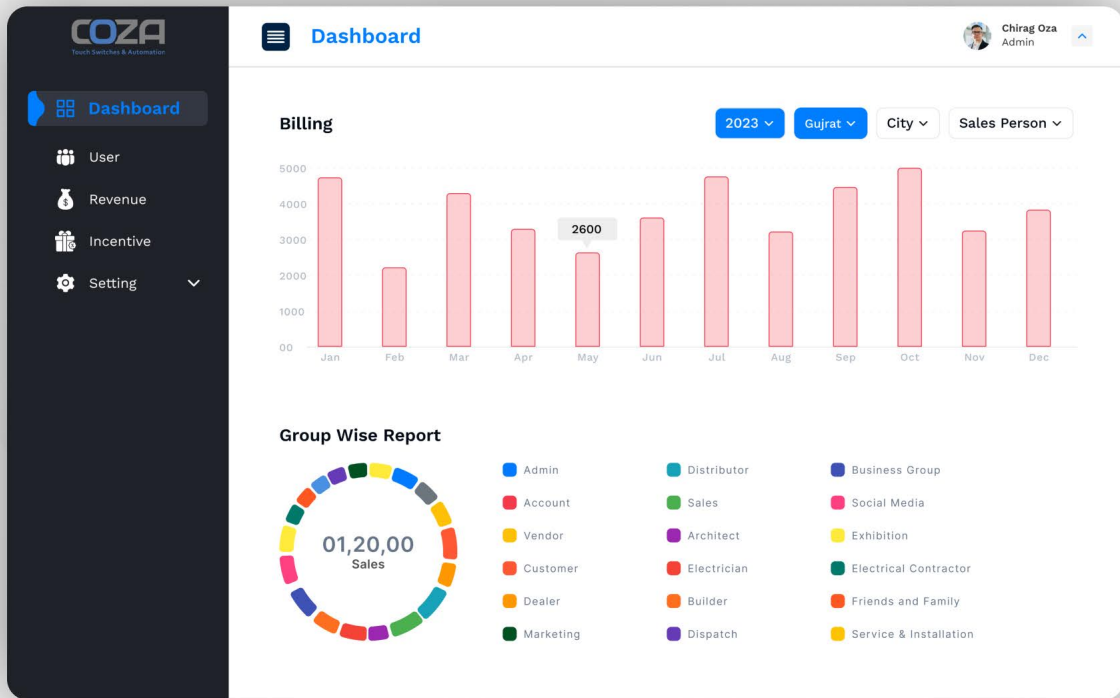

Website:

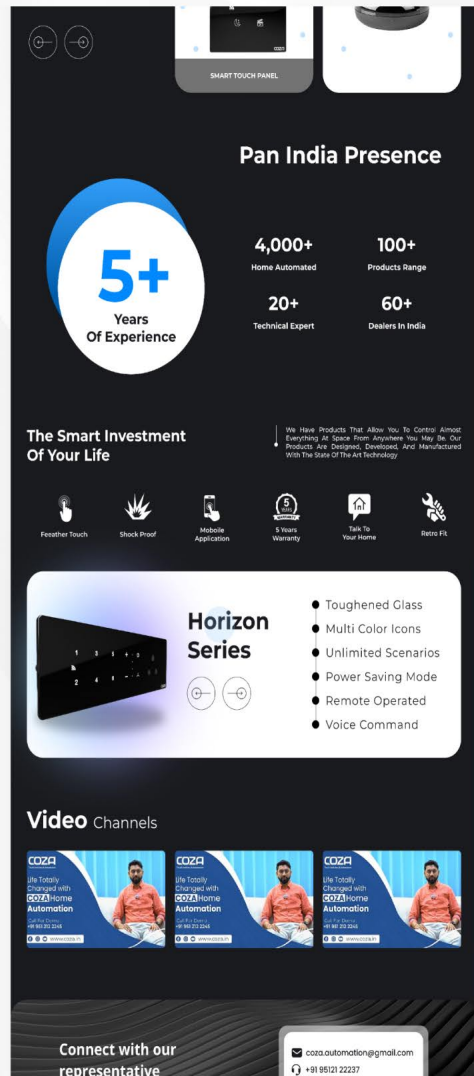
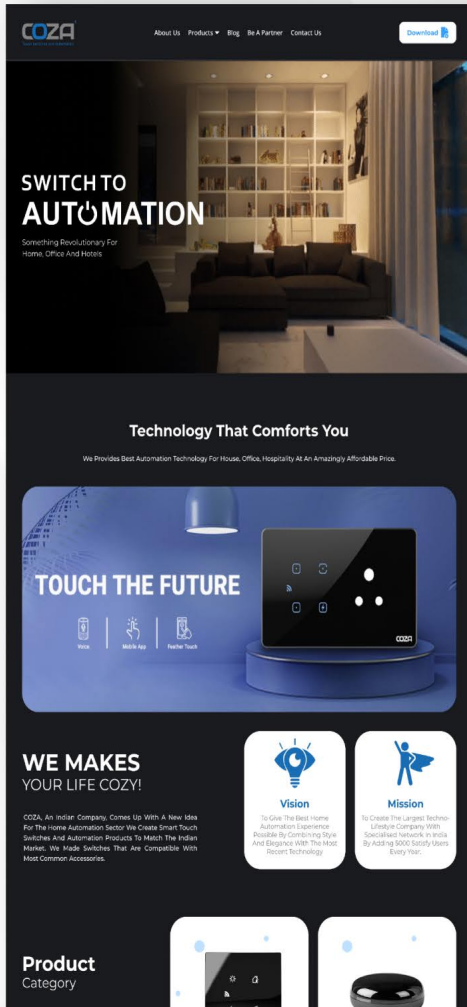

High Five Wash (Mobile App)

The On-Demand Laundry and Ironing company that provides a convenient and hassle-free way for customers to get their laundry and ironing done through. The app connects users with nearby delivery partners, warehouses, and vendors to provide a seamless end-to-end laundry and ironing experience.

Segment:

Laundry Service

Key Features:

- **User-Friendly Interface:** The app features a user-friendly interface that makes it easy for users to place orders, track their status, and receive notifications.
- **Real-Time Order Tracking:** Users can track their orders in real time, knowing exactly when their clothes will be picked up, cleaned, ironed, and delivered.
- **Secure Payment Processing:** The app supports secure payment processing, allowing users to pay for their services easily and conveniently.

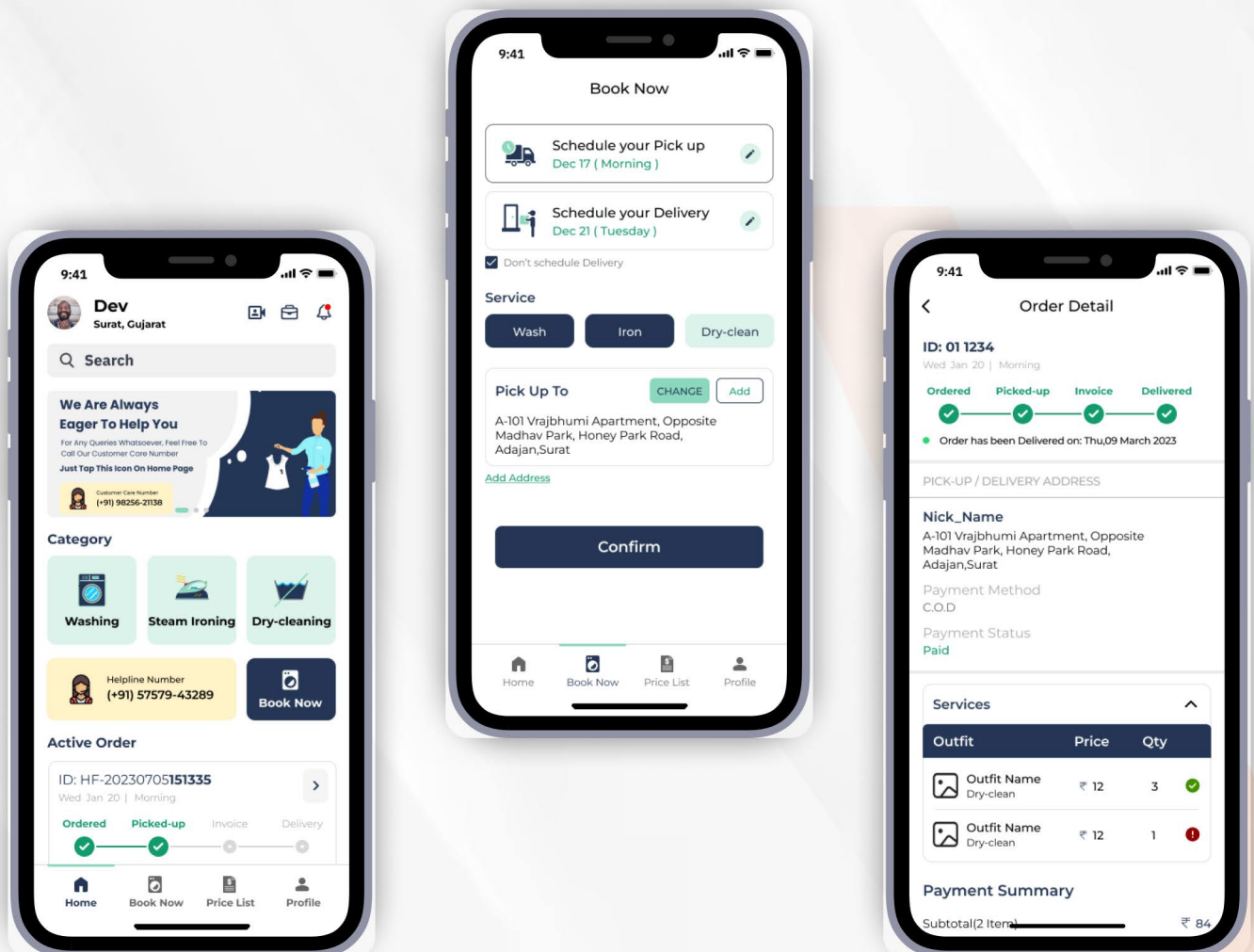



Shraddha AC (Web App)

Client:

Shraddha AC

Segment:

AC Service

Problem:

Shradha AC company is into AC sales and maintenance services. They were using a readymade software to manage calls and their operational activities. While using this readymade platform, they were unable to get many functionalities and reports required, was open for all employees which led to data deletion. Hence contacted us and we successfully delivered following features into a whole new customised software.

Problem:

- Manage Calls of customer for AC repair service.
- Can add multiple address, multiple phone number for each client
- Stock Management.
- Location of AC at client's place. How much material a service person need to carry.
- Job Card can be created in software itself. Earlier they used to upload it on google drive.\
- Reports like Productivity and Repeat Repair are generated.
- Software has been set with permissions so as everyone has access to only those data that are required for their job to avoid unnecessary deletion of data.

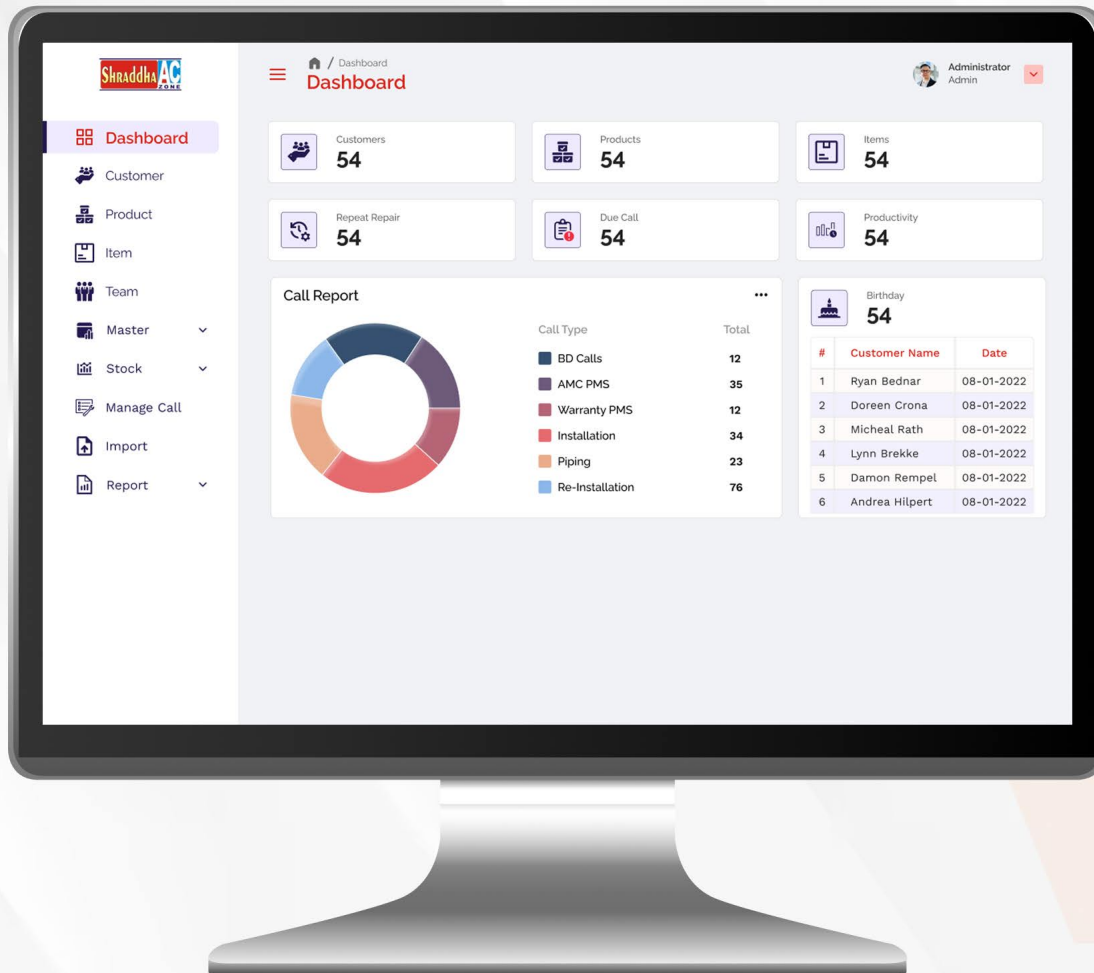

Back Office Dashboard:

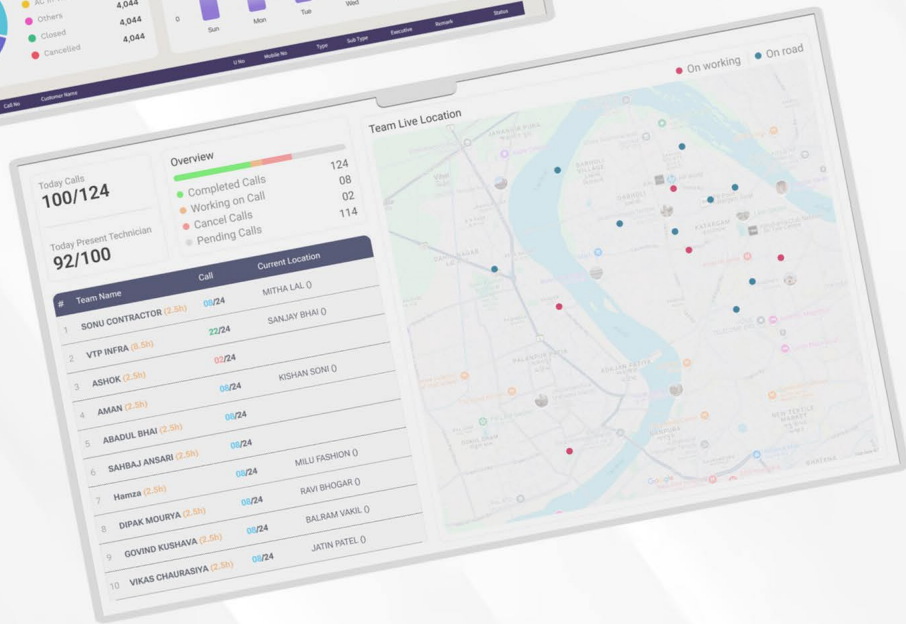

Accounts Dashboard:

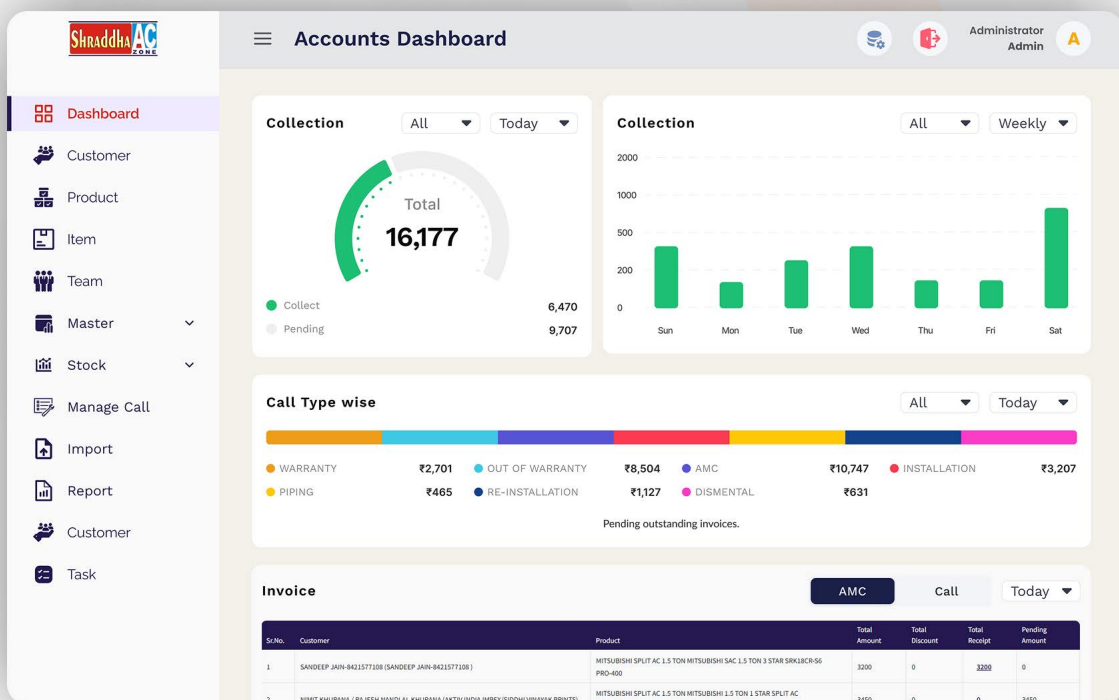

Mobile Application

This app streamlines field service management by providing a structured workflow from task assignment to completion, ensuring smooth communication between the admin team and technicians.

Technicians receive assigned service or repair tasks via the app by admin, which directs them to the customer's location. The app tracks the entire process, from creating service quotations to the final job completion, invoice generation, and customer feedback collection. Additionally, it incorporates attendance and leave management, ensuring that workforce logistics are handled efficiently.

Key Features:

- **Call Assignment:** Admin assigns call with details to technicians.
- **Work Timer:** Tracks time once the technician starts the job.
- **Quotation Creation:** Technicians can create service quotations before beginning work.
- **Progress Updates:** Technicians mark work as partially or fully completed, and generate job cards after completing the work.
- **Customer Signature:** Capture customer signatures to confirm service completion.
- **Attendance & Leave:** Manage daily attendance and technician leave.

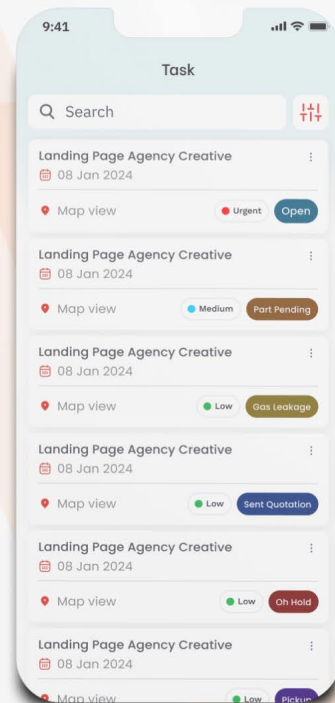
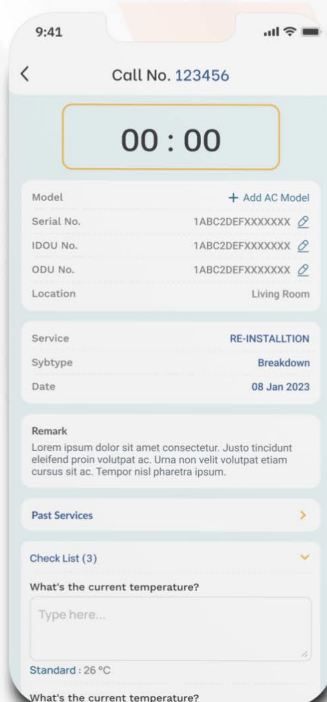
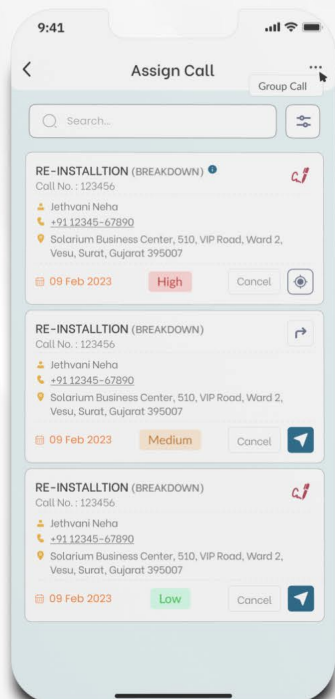
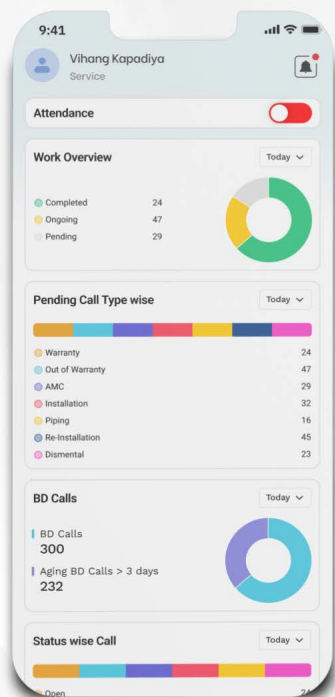

Webledger (UX/UI)

Client:

Web Ledger PVT. LTD. (Ajit Bansali)

Segment:

SaaS Product

Challenge:

WebLedger's existing website was outdated in terms of design and functionality, failing to effectively showcase their accounting software solutions and attract new customers. The website lacked a clear and compelling value proposition, making it difficult for visitors to understand the benefits of using WebLedger's software.

Solution :

Our team embarked on a comprehensive website revamp project to transform WebLedger's online presence and effectively communicate their value proposition. The redesigned website features a modern and user-friendly design, enhanced functionality, and compelling content that showcases the benefits of WebLedger's accounting software solutions.

Key Features:

- **Modern and User-Friendly Design:** The new website boasts a clean and modern design that aligns with WebLedger's brand identity and enhances the user experience.
- **Enhanced Functionality:** Improved navigation, clear calls-to-action, and interactive elements make it easier for visitors to find the information they need and take action.
- **Compelling Content:** Engaging content highlights the features and benefits of WebLedger's accounting software solutions, effectively communicating their value proposition.
- **Responsive Design:** The website is fully responsive, adapting seamlessly to different screen sizes and devices, ensuring a consistent user experience across all platforms.



Zaid Excel Design (Website , Web App , Mobile App)

Zaid Excel Design is an architectural firm. Starting from rebranding , we revamped their website , created web based software and mobile application that manages & tracks their project flow, team members and customer relationship.

Client:

Zaid Shaikh

Segment:

Architect, Interior

Challenge :

Zaid Excel Design, a leading architecture firm, required a professional website, web app, and mobile app to showcase their projects and facilitate client interactions effectively.

Solution :

V Care Technologies developed a suite of digital tools, including a website, web app, and mobile app, to meet their operational and marketing needs.

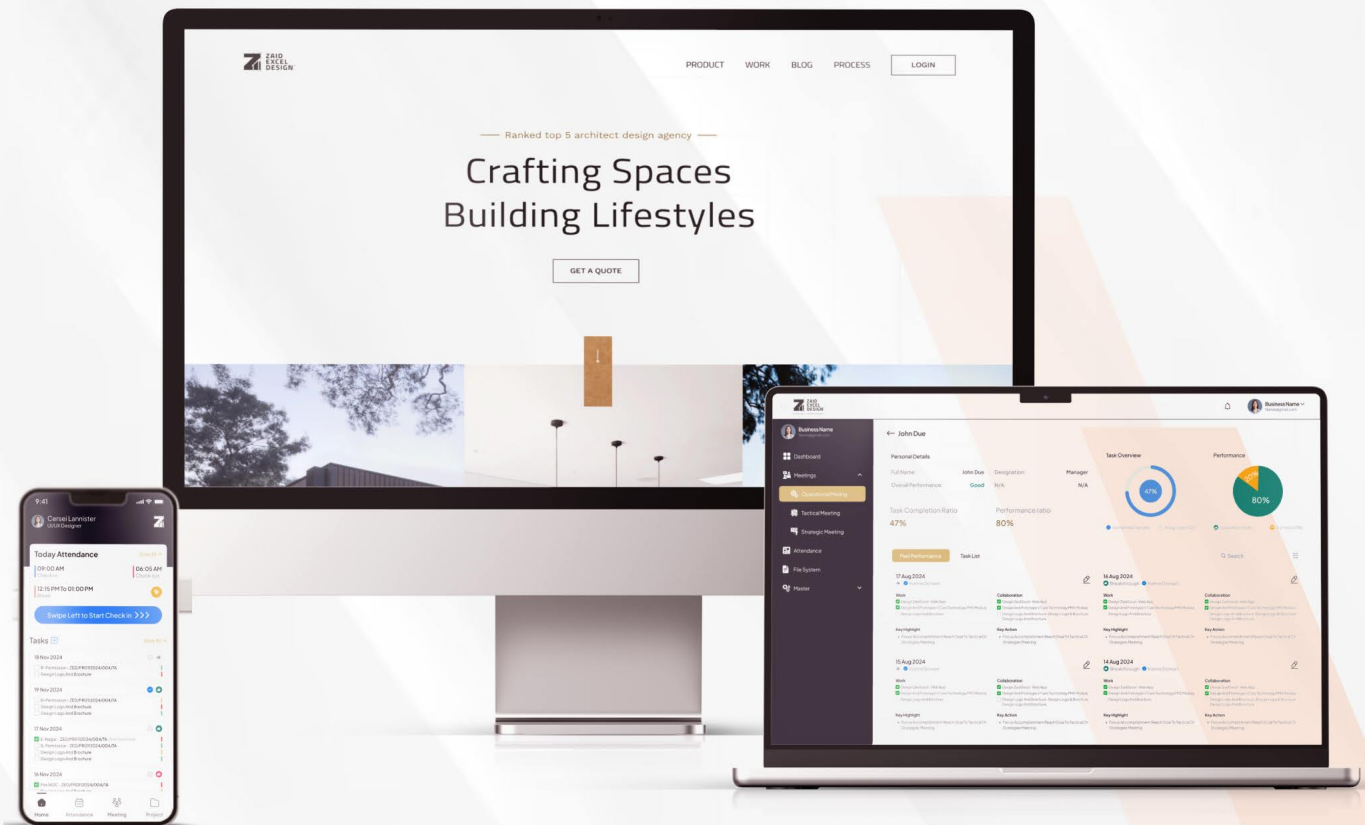

Key Features:

● Website:

- Showcases their portfolio of architectural designs and projects.
- Includes client testimonials and detailed case studies.
- Integrated inquiry form for potential clients.

● Web App:

- Customizable project management tools for internal use.
- Collaborative workspace for clients and architects to share updates and designs.

● Mobile App:

- Provides on-the-go access to project updates and progress reports.
- Push notifications for project milestones and deadlines.

● Admin Panel:

- Centralized control for managing content across platforms.
- Ensures consistent updates for portfolios, blogs, and project details.

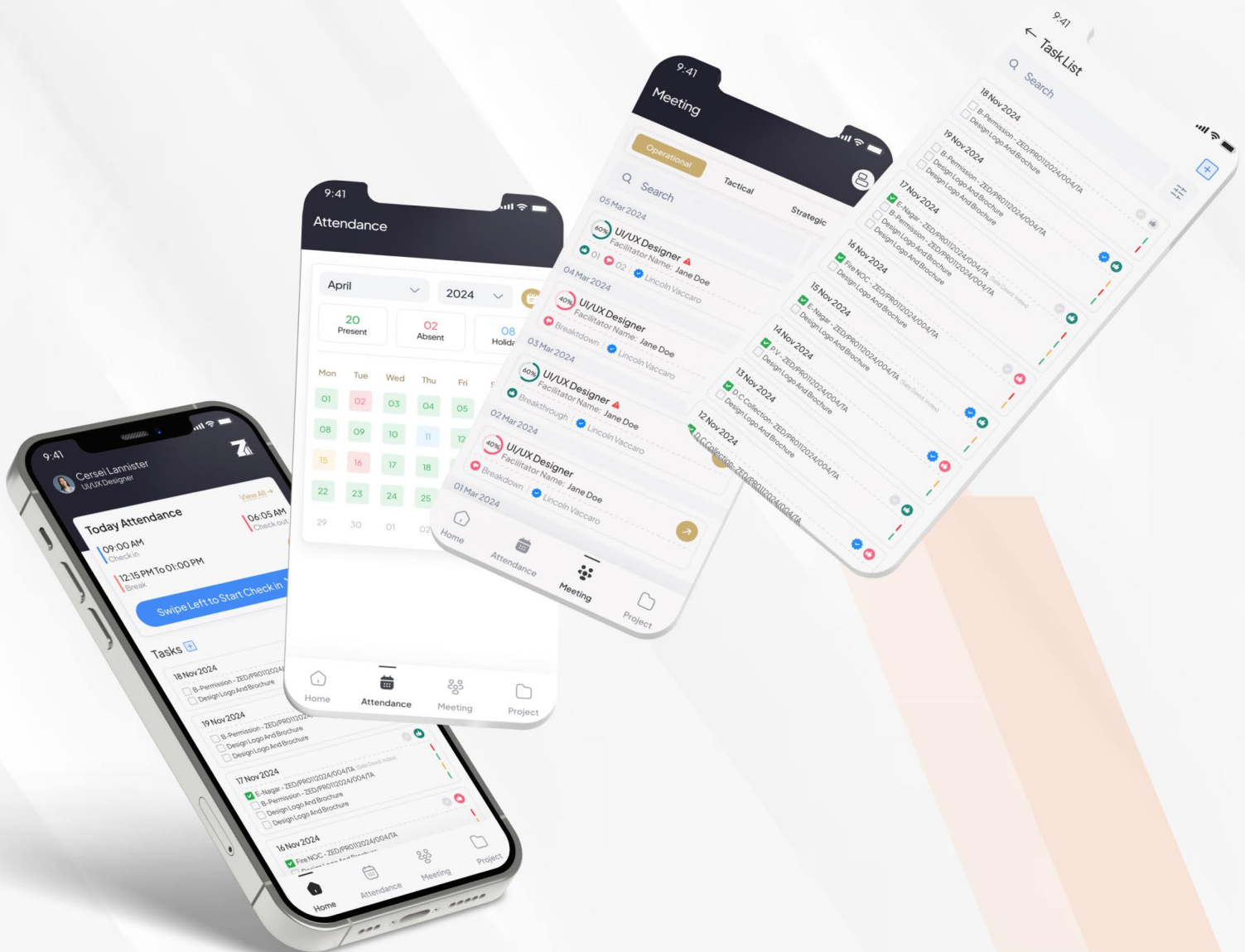

Marill Security (Website , Mobile App)

We played a crucial role in enhancing Maril Security's online presence. We meticulously crafted a visually stunning and user-friendly website for Maril Security, incorporating advanced security features to safeguard their online platform.

The mobile app allows supervisors to capture photos on the field as proof of their presence and activities throughout the day. Supervisors can take multiple photos at different times during a single day, documenting their check-ins and tasks at various locations. Customers can also use the app to see which security guard is assigned to their site, ensuring transparency and real-time updates on security personnel at their premises.

Client:

Manish Pandey

Segment:

Security Agency, Team Recruitment , Housekeeping & Labour Manpower

Challenge :

Before the app, Marill Security struggled with real-time monitoring, inefficient reporting, and no proof of supervisors' presence. Customers had limited visibility on assigned guards, and manual task tracking led to errors. Communication and quality control were challenging, affecting operational efficiency and customer satisfaction.

Solution :

V Care Technologies developed a mobile app for real-time supervisor monitoring, photo documentation, and task tracking. It enhances customer visibility, improves communication, and boosts operational efficiency.

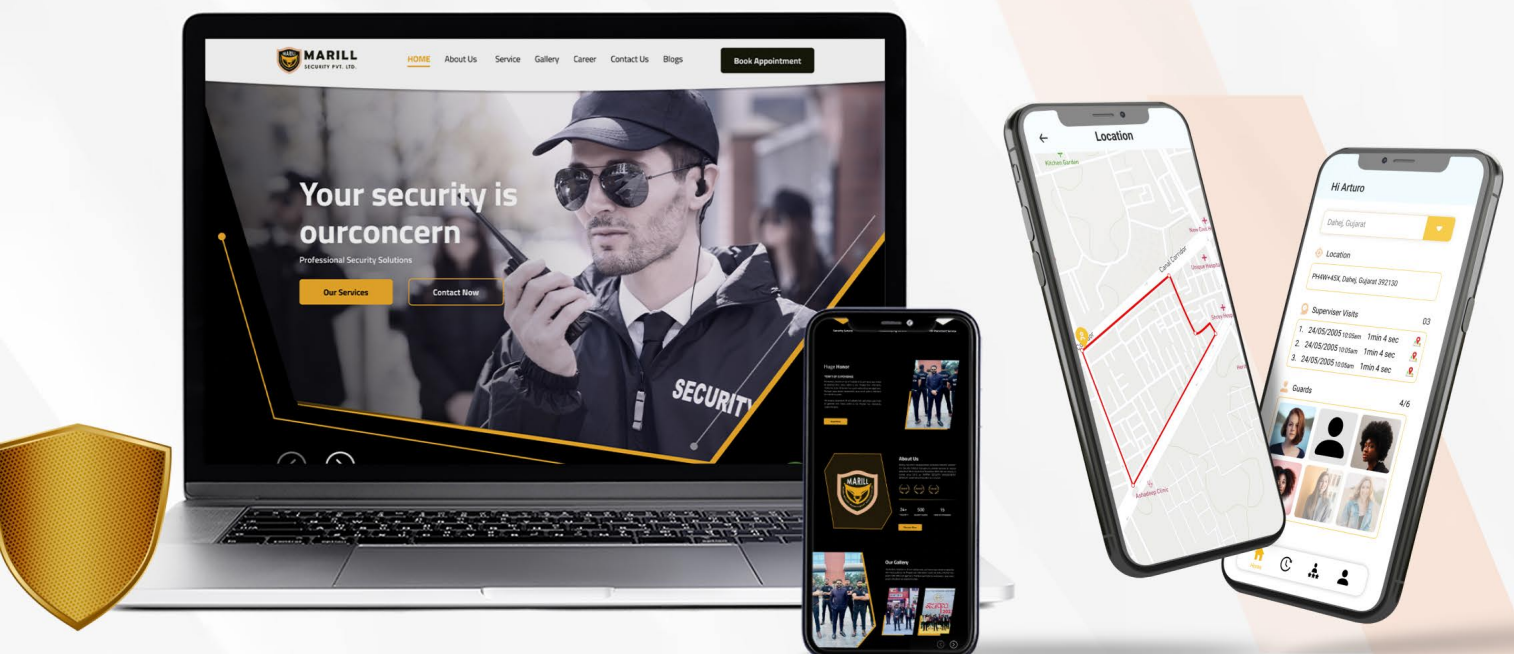

Gopi Synthetics (Mobile App , Web App)

The system streamlines operations by automating route scheduling, centralizing dealer data, and improving communication. It enables real-time mobile access for teams to track orders and payments, while simplifying stock management. The system also offers dealers an efficient browsing and inquiry platform, enhancing both service quality and operational efficiency. This solution improves coordination, reduces errors, and ensures timely deliveries, providing a seamless experience for both the team and dealers.

Client:

Gopi Synthetics

Key Features:

- **Real-Time Stock Updates:** Dealers can access current product availability instantly.
- **Simplified Inquiry System:** Streamlines dealer communication.
- **Admin Panel:** Ensures smooth product and stock management.

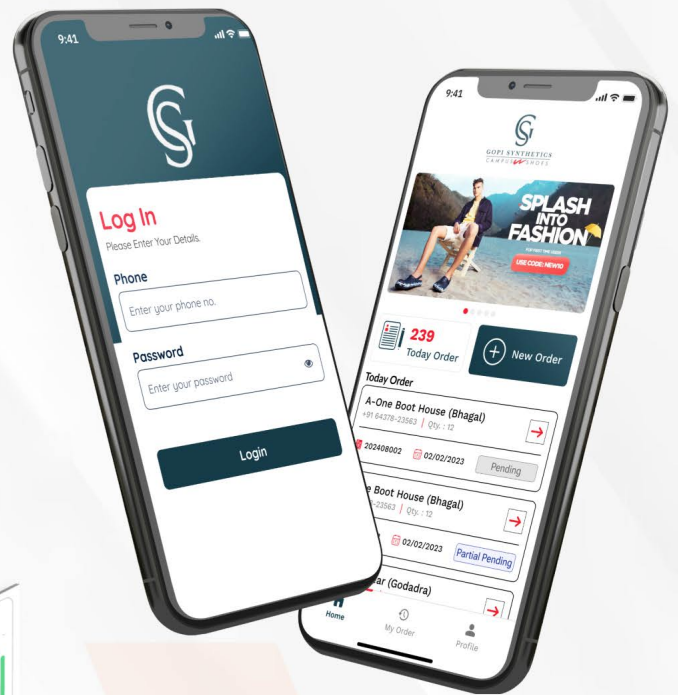

Jagdisha Blinds (Mobile App , Web App)

Jagdish Impex is a platform that connects dealers, distributors, and administrators to streamline inventory management and order fulfillment. Dealers can view stock, place orders, and track order details. Admins manage vendors, products, inventory, and handle order processing. The system ensures efficient operations and better communication across the supply chain.

Client:

Suresh Bhardwaj

Key Features:

- **Admin Panel:**
 - Manage vendors and product catalog.
 - Track and update inventory from vendors.
 - Accept and process dealer orders.
- **Dealer App:** Dealers can access current product availability instantly.
- **MOQ Integration:** Ensure orders meet the minimum order quantity for each product.

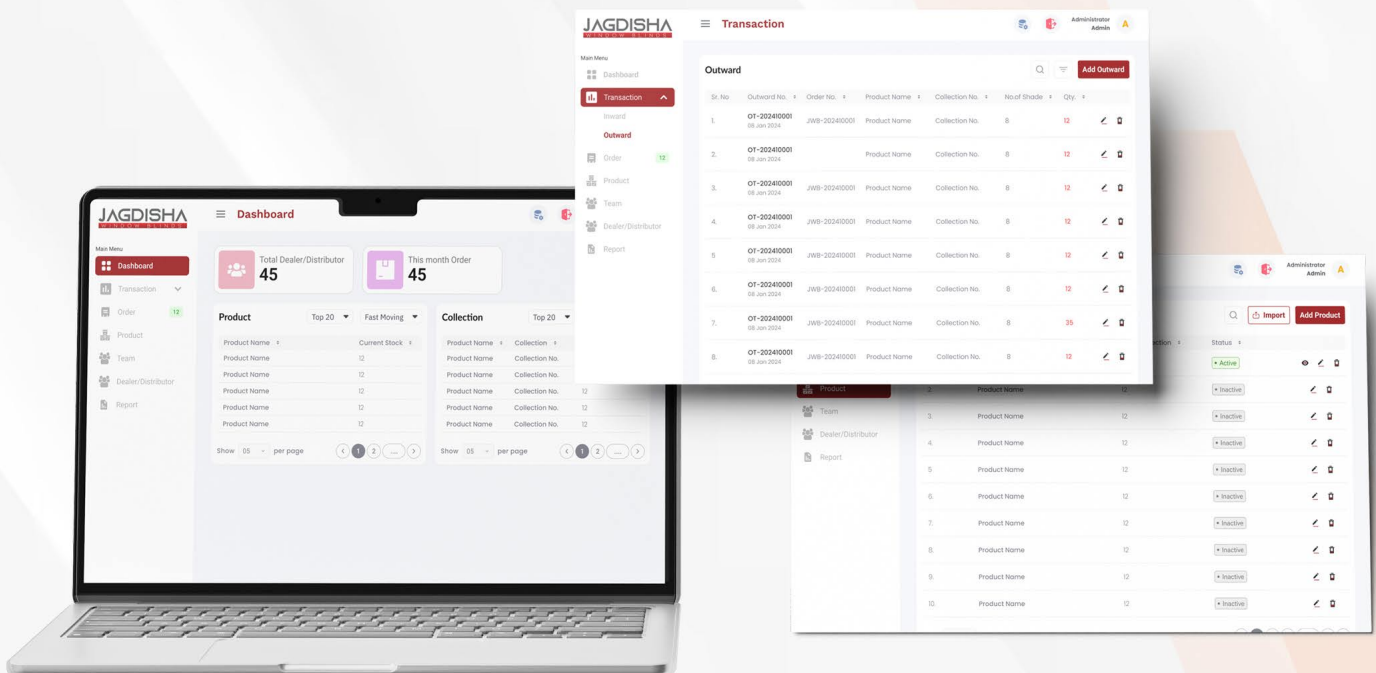
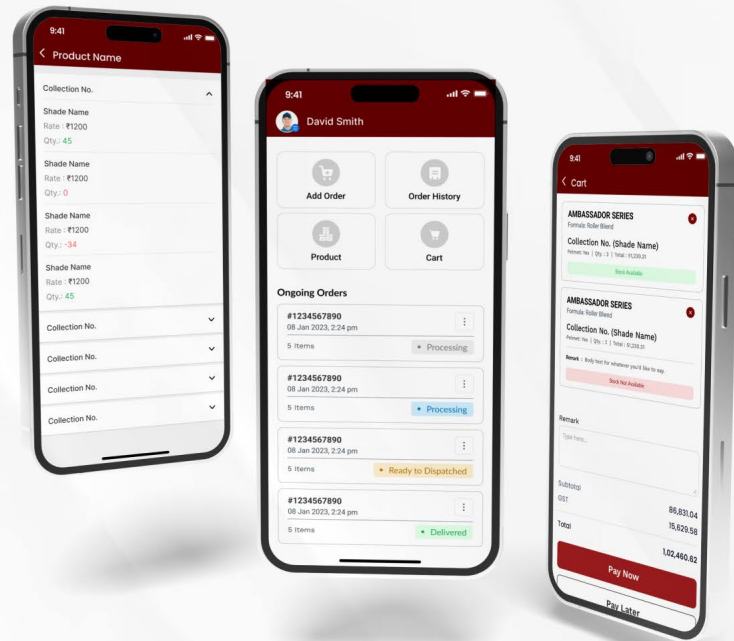



TUTOR VILLE
KNOWLEDGE IS POWER

Tutor Ville (UX/UI)

We successfully designed an intuitive online teaching platform for Tutor Ville, empowering them to deliver interactive and seamless virtual learning experiences to students worldwide.

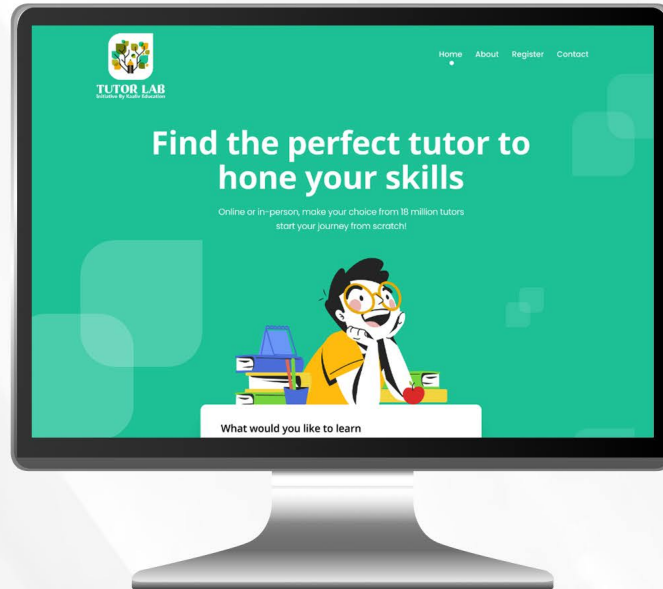

MARH (Website , Mobile App)

We successfully delivered a modern and user-friendly website and mobile application for Moosa Abdul Rahman and Co. (MARH) to manage their car servicing process.

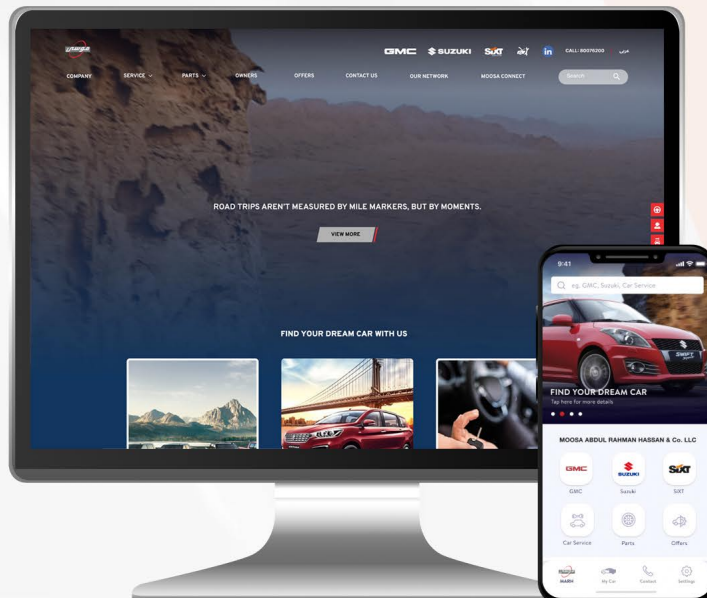



Amatullah Ridas (Web App)

Segment :

Women's Clothing Dealer

Challenge :

Relied on manual Excel sheets for operations, resulting in inefficiency and slow processes.

Solution :

A fast and responsive web application was built using Next.js to modernize their operations.

Key Features:

- **High Performance:** Ensures quick data processing and navigation.
- **Streamlined Interface:** Designed for efficient task management.
- **Custom Performance Enhancements:** Tailored to meet specific operational needs.



Jhakaas Holidays (Website)

Client :

Saksham Goyal

Challenge :

Customers found it difficult to explore and inquire about vacation packages online due to outdated systems.

Solution :

An attractive and user-friendly website was developed to simplify the browsing and inquiry process.

Key Features:

- **Interactive Design:** Boosts customer engagement.
- **Simplified Package Exploration:** Users can easily find and compare vacation options.
- **Efficient Inquiry System:** Enhances communication between the business and customers.

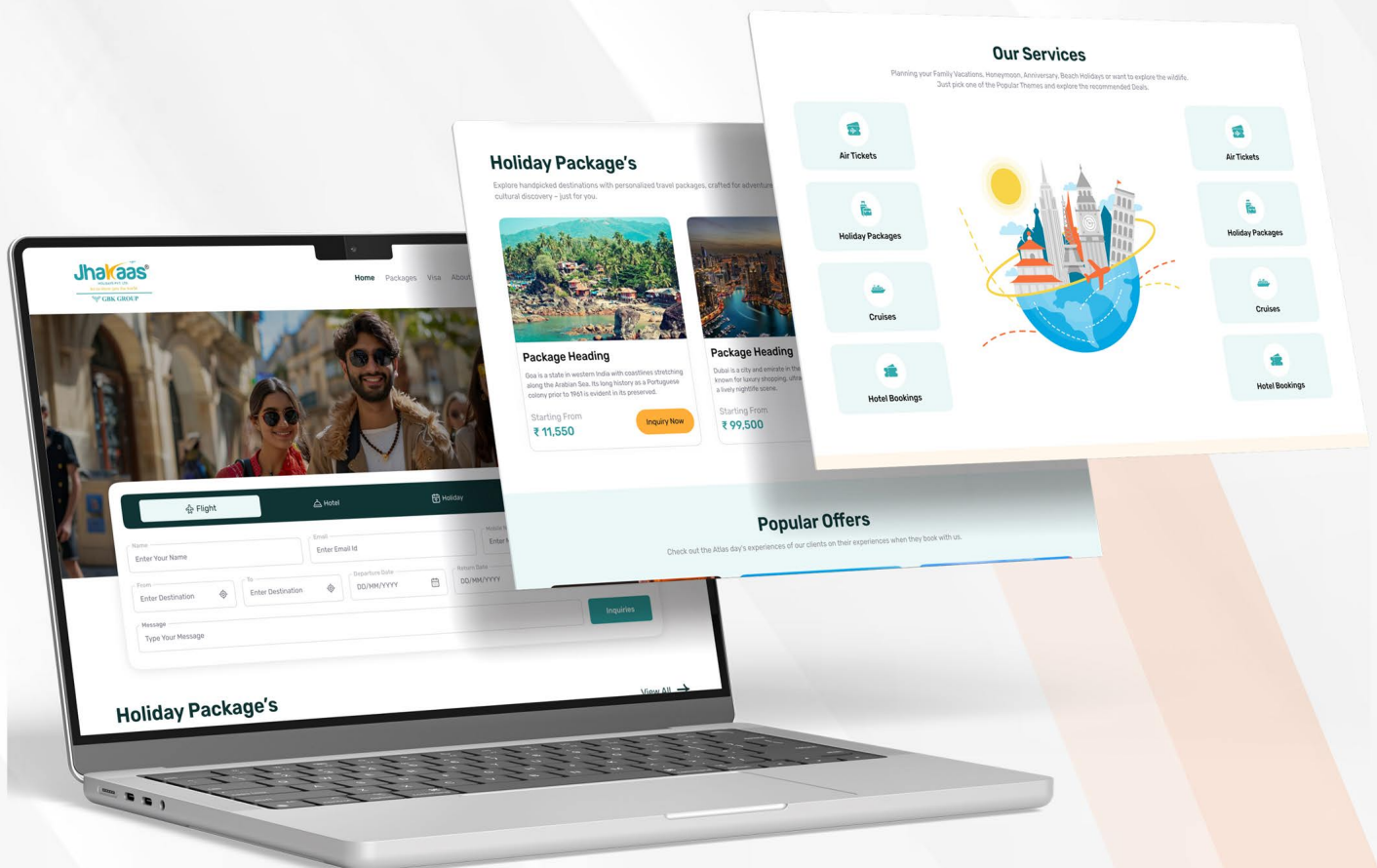



Unlisted Xchange (Website)

Client :

Jenish Shah

Challenge :

The platform lacked digital infrastructure to educate and connect potential investors with unlisted shares.

Solution :

A secure and intuitive platform was developed to facilitate the exploration of unlisted share opportunities.

Key Features:

- **Interactive Design:** Easy navigation for investors to explore investment options.
- **Secure Transaction Gateway:** Ensures data security and seamless operations.
- **Admin Control Panel:** Simplifies content updates and user management.

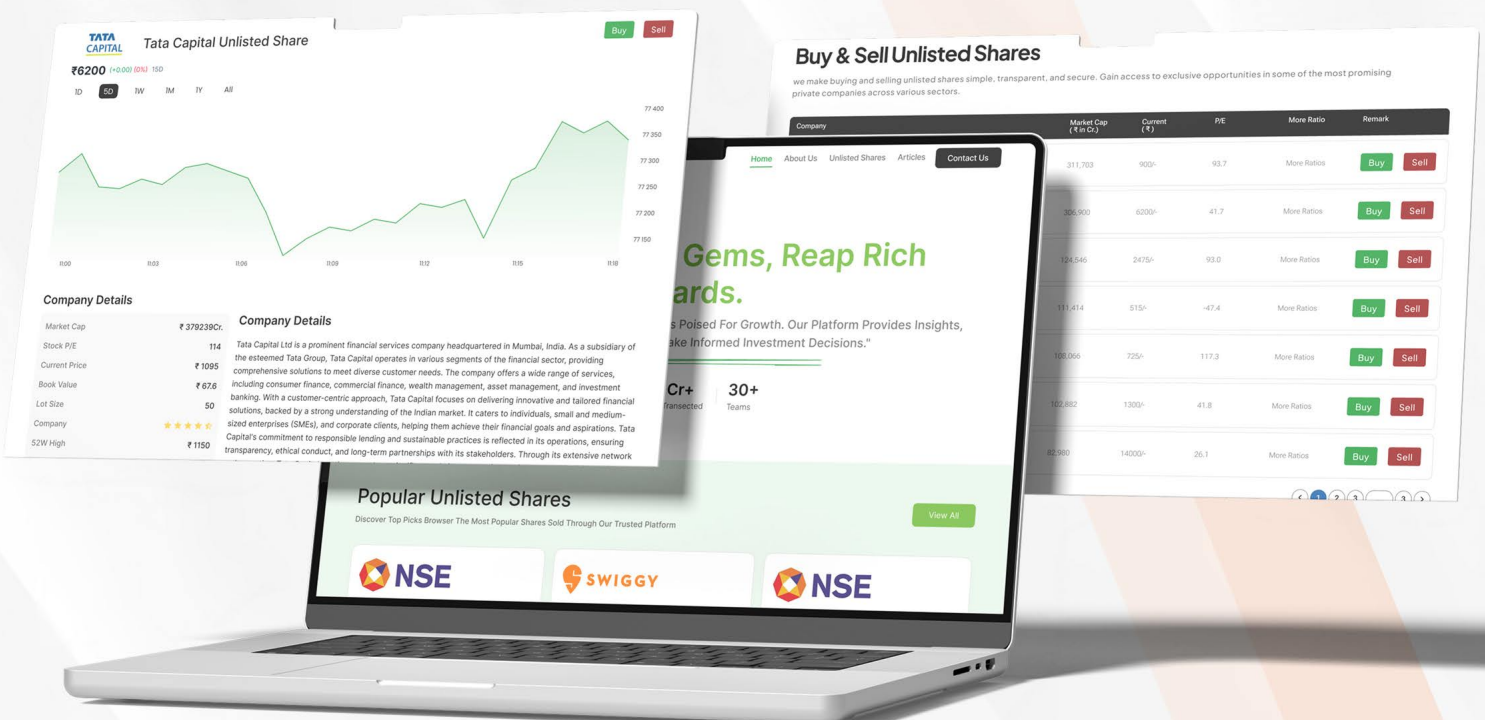



Imperium Ventures (UX/UI)

We collaborated with Imperium Ventures to design a dynamic e-commerce website specifically tailored for their flour mill machines business.

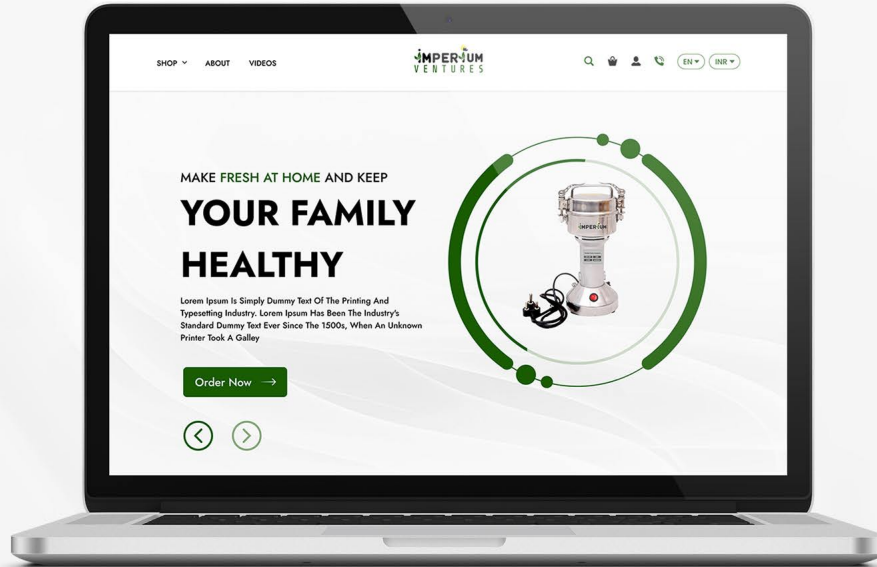

The Urban Lab (Website)

A project by an urban design company to showcase their projects completed all over india along with their publications.

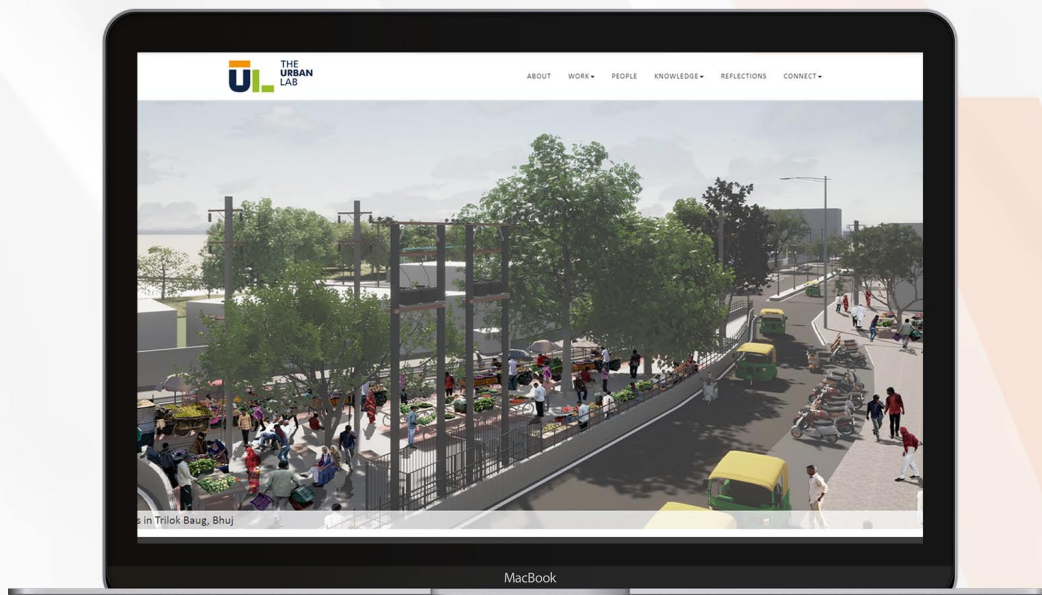



Monkey Adventure Kart (Booking Site)

Online booking platform for city ride in Japan, Tokyo with online payment.

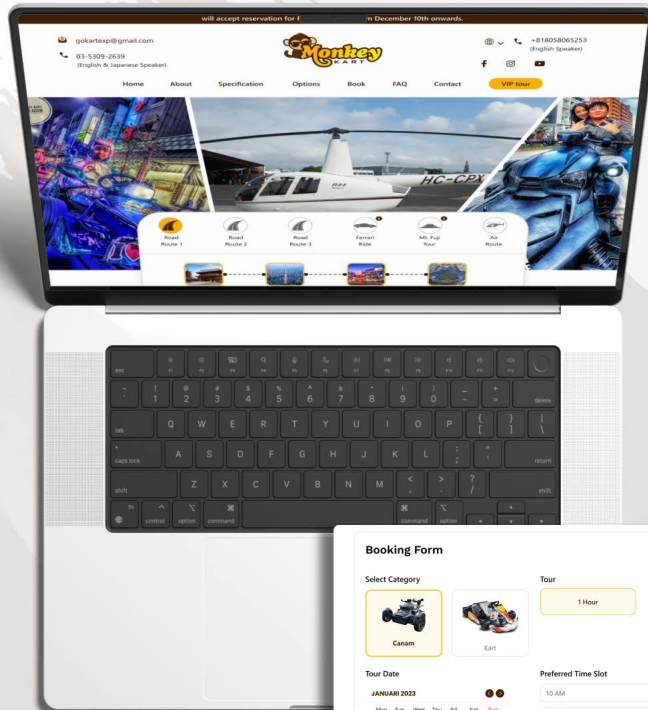
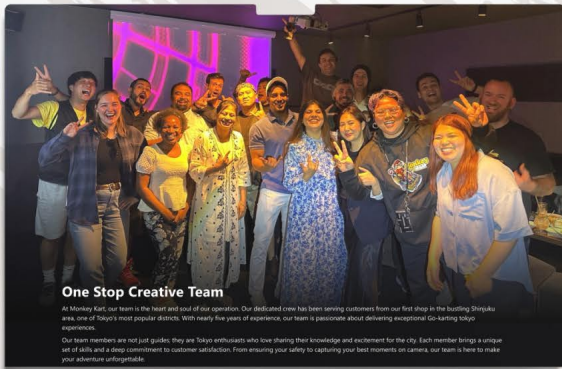

Additional Benefits

Our Tokyo go kart tour goes beyond just karting. Our professional guides, trained in photography, will capture your best moments. Enjoy complimentary drinks and souvenirs, and benefit from our multi-language support for better communication. With exclusive routes covering popular Tokyo landmarks, your adventure will be truly special.

Professional Photography

Guides trained in photography to capture your best moments.

Free Drinks and Souvenirs

Complimentary beverages and souvenirs provided.

Multi-language Support

Guides fluent in multiple languages for better communication.

Exclusive Routes

Access to special routes covering popular Tokyo landmarks.

Booking Form

Select Category: Canam Kart

Tour: 1 Hour

Tour Date: JANUARY 2023

Mon	Tue	Wed	Thu	Fri	Sat	Sun
1	2	3	4	5	6	7
8	9	10	11	12	13	14
15	16	17	18	19	20	21
22	23	24	25	26	27	28
29	30	31				

Preferred Time Slot:

- 10 AM (Not AVL)
- 12 PM (AVL 2 Ride)
- 02 PM (AVL 8 Ride)
- 04 PM (Not AVL)
- 06 PM (AVL 1 Ride)

Ride: 2

Personal Information

Full Name*

Mobile Number*

Country*

Address*

Price Details

Base Fare: ¥20000

Ride (Base Fare x n): 2

Total: ¥40000

Select Category: PayPal Pay by Card Pay by Card

All participants must bring and hold a hardcopy of valid Japanese drivers license, Japanese SOFA license, or an International Driving Permit based on the 1949 Geneva Convention for this experience. Do you and all participants hold a hardcopy of valid license? Yes

I Accept the [Terms & Conditions](#).





MYTS (UI/UX, Website)

E-commerce platform selling outdoor, indoor, and scooter toys for children in the UAE.

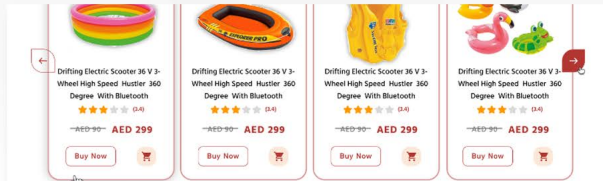

We Work With The Best Partners

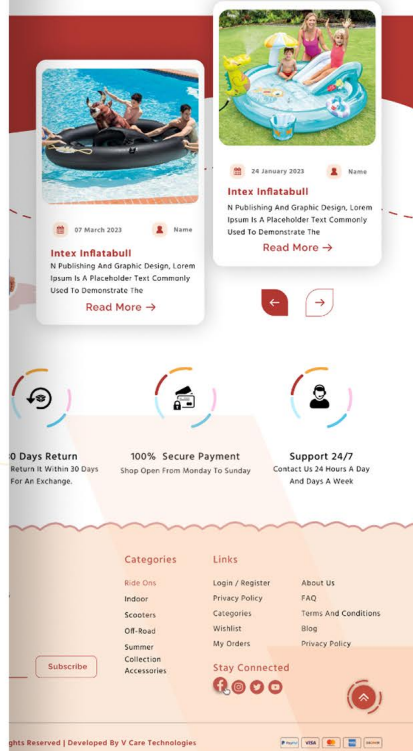
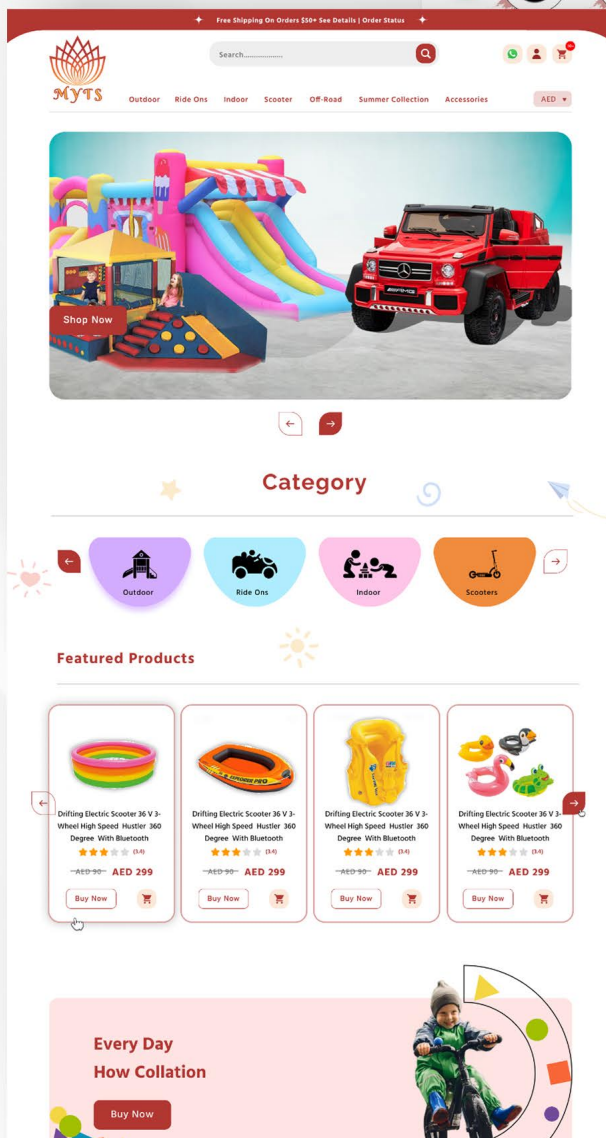

Wolton (Website)

Challenge :

The platform lacked digital infrastructure to educate and connect potential investors with unlisted shares.

Solution :

A secure and intuitive platform was developed to facilitate the exploration of unlisted share opportunities.

Key Features:

- **Interactive Design:** Easy navigation for investors to explore investment options.
- **Secure Transaction Gateway:** Ensures data security and seamless operations.
- **Admin Control Panel:** Simplifies content updates and user management.

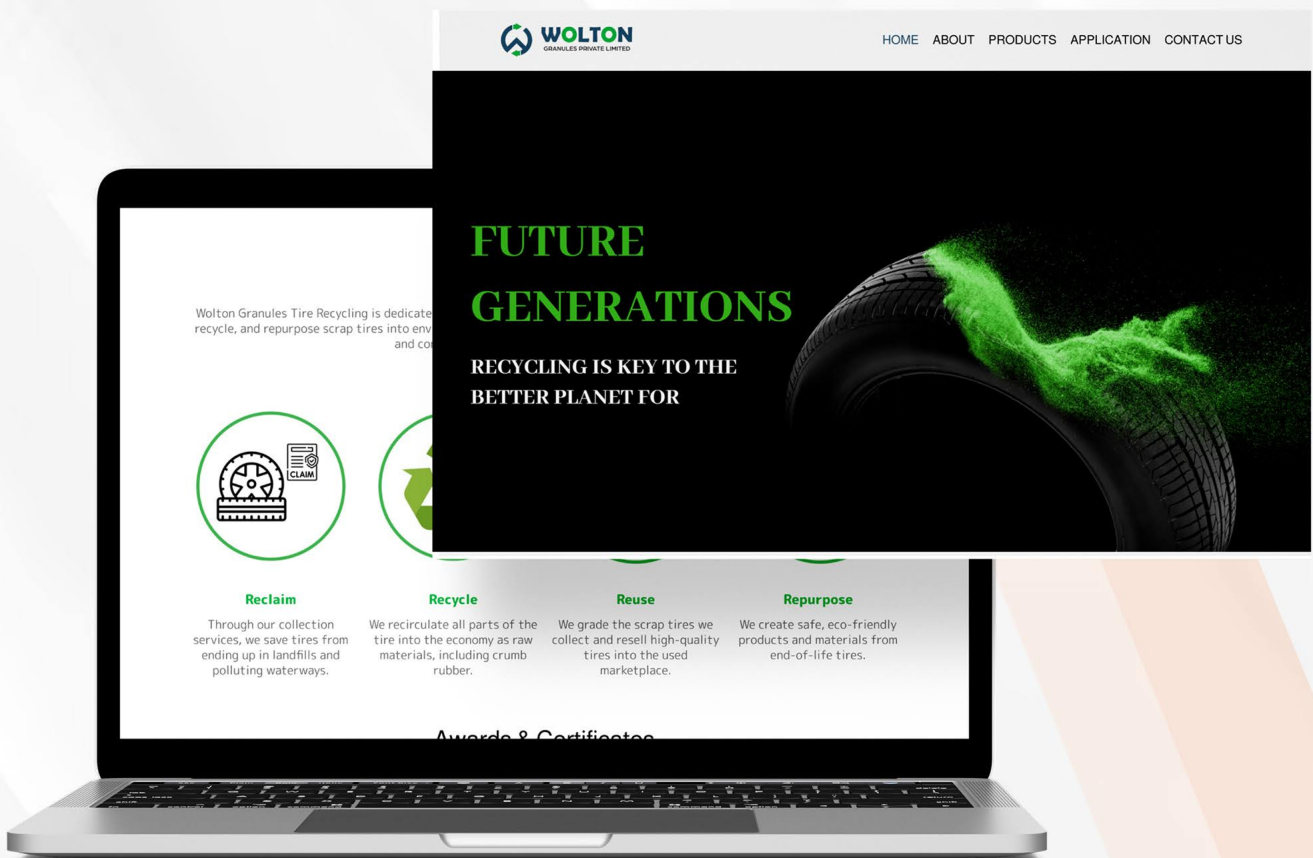

Super Enterprise (Website)

Challenge :

Super Enterprise, an exporter of spices and used ship automation parts, lacked an online presence, which hindered their global reach and sales growth.

Solution :

A professional and user-friendly website was developed to represent their business effectively.

Key Features:

- **Detailed Product and Service Showcase:** Comprehensive descriptions and visuals for spices and automation parts.
- **Global Audience Appeal:** Designed to attract clients from markets like the UAE and USA.
- **Intuitive Navigation:** Enhances user experience and drives engagement.

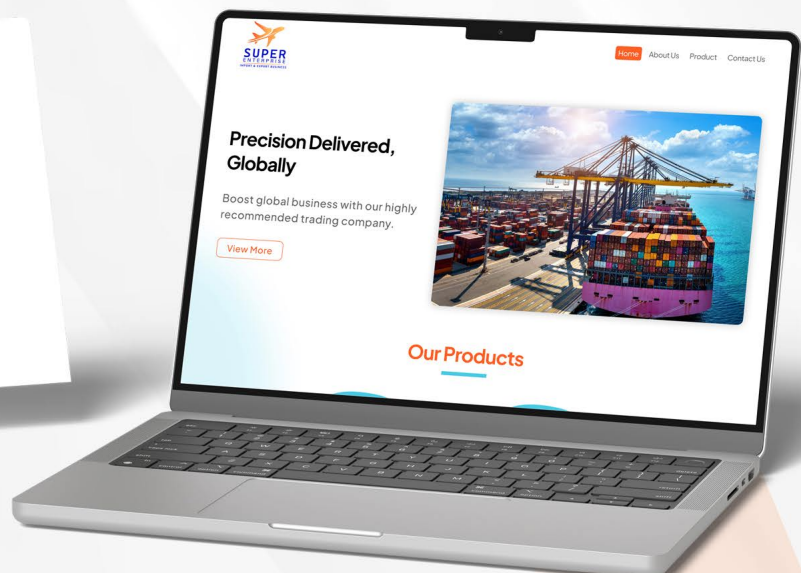
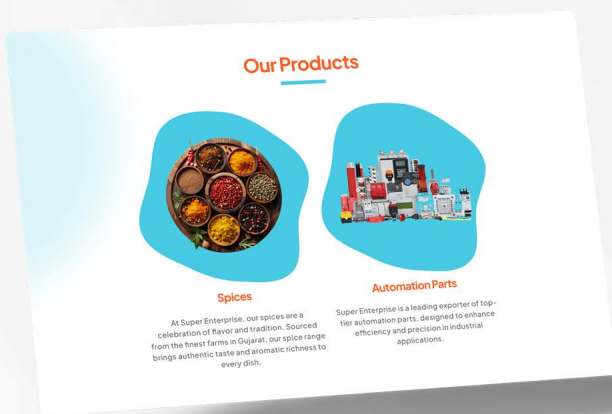

Evaluation Aspects (Mobile App , Web App)

Client :

Prince Mistry

Segment :

Property Valuation

Challenge :

The client struggles with managing the property valuation process using Excel sheets, which leads to inefficiencies, errors, and difficulty tracking updates across multiple stages. The lack of automation and centralized tracking results in delays, communication issues, and challenges in maintaining accurate records.

Solution :

The system streamlines property valuation for banks by managing the process from request submission to final file submission. After receiving a valuation request, the admin schedules a site visit, which is assigned to a site visitor. The visitor updates the property details, which are sent to a drafter for processing. Any queries are resolved, and once the draft is complete, a PDF report is generated. The file is then assigned to a file collector, who submits it to the bank, updating the status in the app at each stage.

Key Features:

- **Centralized Dashboard:** Streamlines the entire property valuation process in one platform.
- **Automated Task Assignment:** Automatically assigns tasks to the drafter after site updates.
- **Query Management:** Allows to raise and resolve queries, updating status accordingly.
- **PDF Report Generation:** Automatically generates finalized PDF reports after review.



Quantum Technical Services (Website)

Client :

Abbas

Segment :

Dealer of Industrial Equipment

Challenge :

QTS India lacked a professional online presence to showcase their quality testing services and expertise, impacting their credibility and outreach.

Solution :

V Care Technologies designed a clean and modern website to effectively highlight their services.

Key Features:

- **Professional Design:** Represents their expertise and quality services.
- **Streamlined Navigation:** Allows users to explore services effortlessly.
- **Admin Panel:** Ensures easy updates to content and services.
- Additionally, V Care Technologies created websites tailored for two countries—USA and India—with designs and themes customized to suit the specific needs and preferences of each market.

UAE Website



Florida Decor (Mobile App)

Challenge :

Florida Decor, a manufacturer of premium home textiles, faced challenges in enabling their dealers to browse products like bedsheets, pillows, and curtains efficiently. Additionally, the process for submitting inquiries was cumbersome and inefficient.

Solution :

V Care Technologies developed a robust wholesale app that streamlined product browsing and inquiry submission for dealers.

Key Features:

- **Comprehensive Product Display:** Premium home textile products are categorized and displayed for easy browsing.
- **Effortless Inquiry Management:** Dealers can submit inquiries quickly and conveniently.
- **Admin Panel:** Enables efficient management of stock updates, new product launches, and dealer inquiries.

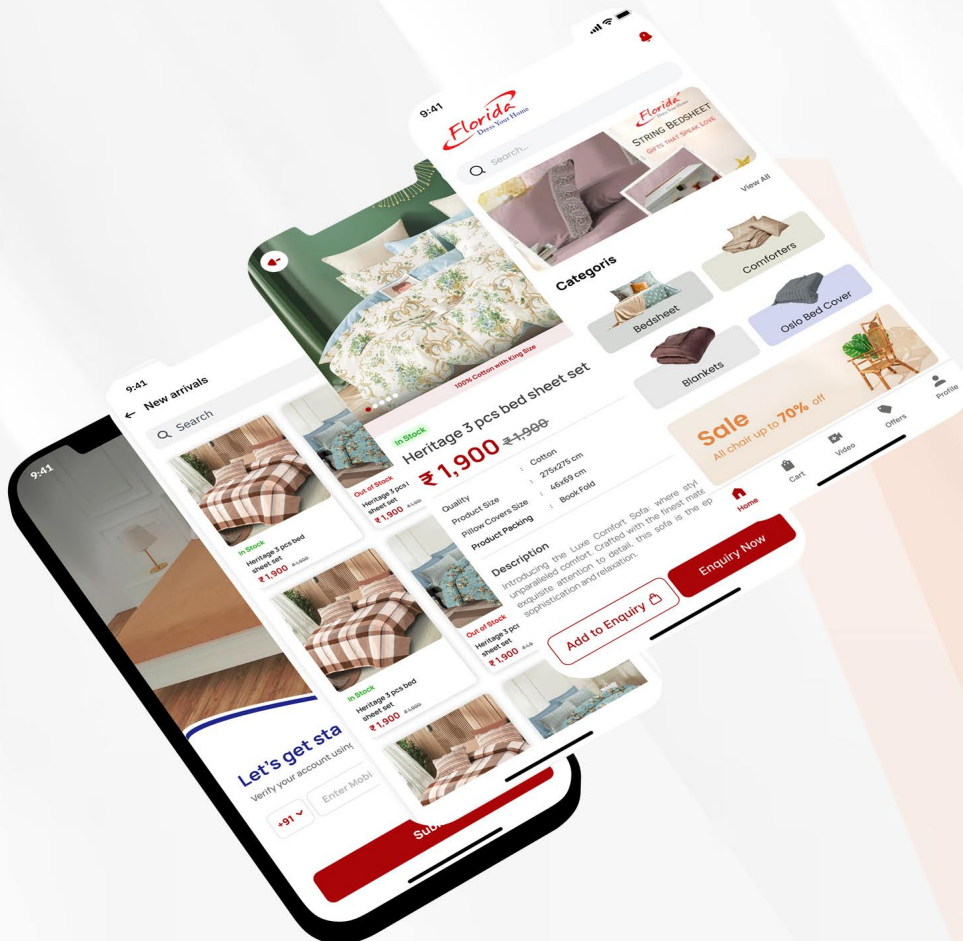



Fabric Souq (Website)

Challenge :

Fabric Souq required a secure e-commerce platform for selling men's and women's clothing materials while providing a seamless shopping experience.

Solution :

A tailor-made e-commerce website was created to enhance user engagement and drive sales.

Key Features:

- **User-Friendly Design:** Simplified navigation for a hassle-free shopping experience.
- **Secure Payment Gateway Integration:** Ensures safe and smooth transactions.
- **Admin Dashboard:** Enables easy product uploads, order management, and transaction tracking.





Infiniti8 (Website)

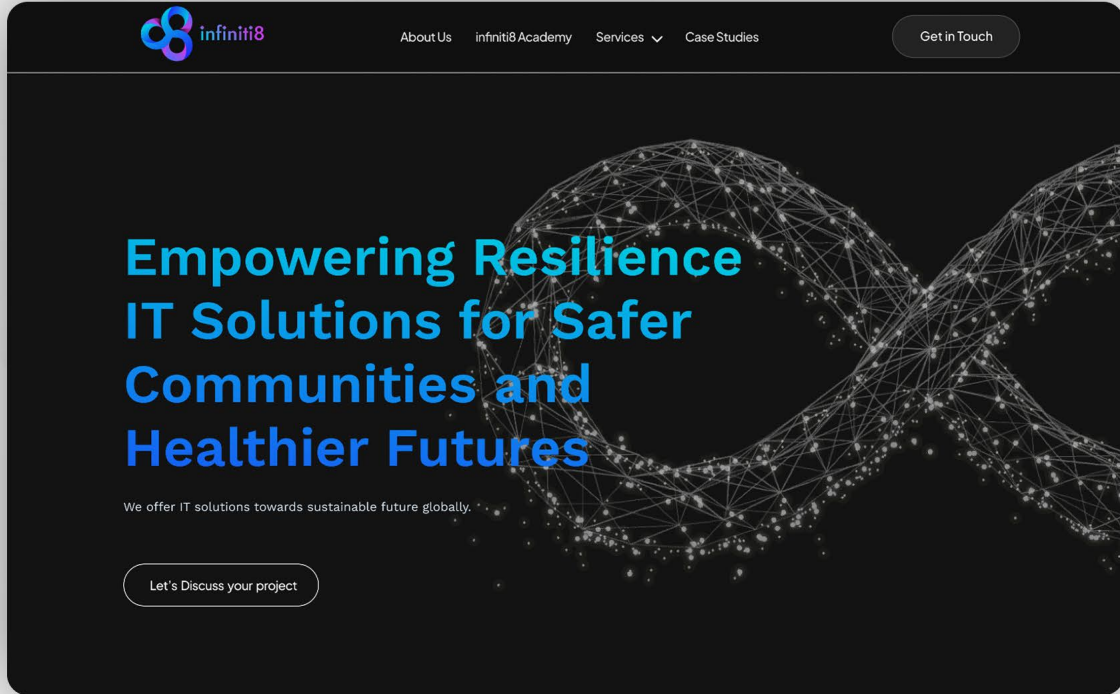

Heatbird (Website)

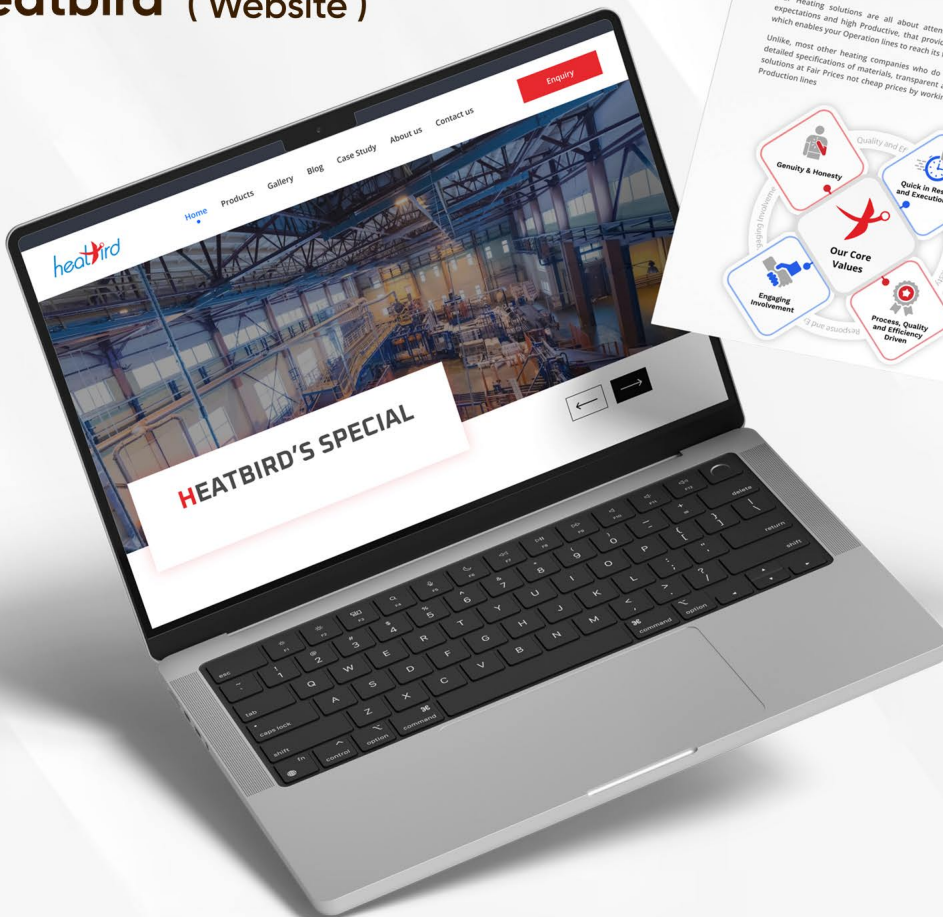



Foot Impact (Website)



NaviCure Tech



www.navicure.com

We've been using Untitled to kick start every new project and can't imagine working without it.

Candice Wu



Stanley Safety (Website)

DON'T JUST TAKE OUR WORDS

Jenny Wilson Grower.io

★★★★★

"We love Landingfolio! Our designers were using it for their projects, so we already knew what kind of design they want."

Jenny Wilson Grower.io

★★★★★

"We love Landingfolio! Our designers were using it for their projects, so we already knew what kind of design they want."

Stanley SAFETY

Home About Us Products Gallery Contact

Enquire Now

Together we build SAFER work places

Stanley Safety Products provides solutions to industrial establishments in dealing with the requirements of work place hazards that are generated by industrial machinery and environment around it. Our core business has long been the Distribution and Manufacturing of safety products and safety services. Today, we're increasingly focused on the rising demand for safety services. The requirement to assess the likelihood of an injury in the work place can be a very complex task even though there are volumes of safety standards available.

Download Brochure

LOOKING TO BETTER UNDERSTAND YOUR PRODUCT OPTION

Of The Printing And Typesetting Industry, Lorem and Dummy Text Ever Since The 1500s, When An e And Scrambled It To Make A Type Specimen Book.

ABOUT US

Every safety measure counts. When you protect a worker, you safeguard a precious life.

- STANLEY SAFETY specialises in the manufacturing of safety products.
- The facility covers an area of 1 acre and employs over 100 skilled employees.
- To sustain and surpass its commitment, STANLEY SAFETY consistently invests in the necessary resources.
- This includes working closely with suppliers on new product innovation and development.
- This includes working closely with suppliers on new product innovation and development.
- This has made it possible to produce products that suit the Indian physiological profile.
- These products take into account fit, comfort, preference, and the tropical climate.

2006.

To Our

Quick Link

- Home
- About Us
- Safety Products
- Gallery
- Contact
- Privacy & Policy
- Terms & Condition

Contact

- +912895585855
- andrew@gmail.com
- A- 511-512, Solarium Business Center, VIP Road, Vesu, Surat, Gujarat

© 2023 Stanley SAFETY. All Rights Reserved | Developed by V care Technologies

SAFETY PRODUCTS

- Goggles
- Respiratory Masks
- Reflective Jackets
- Safety Belts
- Coveralls

- 16%** of noise-exposed tested construction workers have hearing impairment in both ears
- 25%** of noise-exposed tested construction workers have a material hearing impairment (impacts day-to-day activities)
- 51%** of construction workers have been exposed to hazardous noise
- 14%** of construction workers have difficulty hearing



Tirich (Web App)

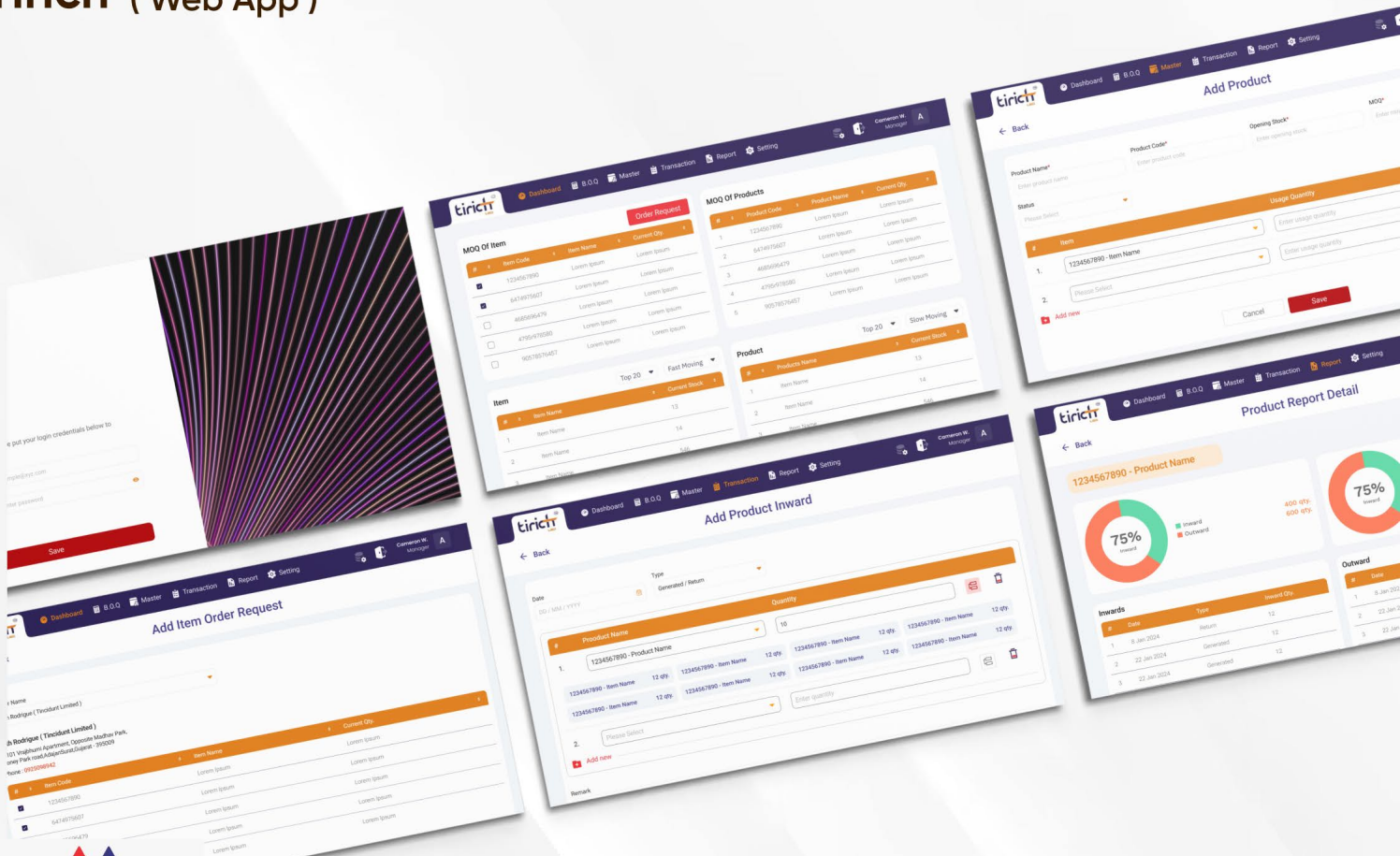

Mahavir Glass (Web App)



Bill & Receipt Print

Malavir Glass
510 Solarium Business Center, VIP Road, Ward 2, Vesu, Surat, Gujarat 395007
(Mo) :- +91 99749-79279

Bill Copy

M/s. : **MURTUZA TARWALA**
510 Solarium Business Center, VIP Road, Ward 2, Vesu,
Surat, Gujarat 395007
(Mo) :- +91 99749-79279
(Add) :- info@vcaretechnologies.net

Quotation No. : 20230901001
Date : 01/09/2023

Sr.	Product	X Size	Y Size	Qty.	Sqft.	Rate	Amt.
01	6mm Plain Glass (Hall) • Dhar Polish • Buff	16	24	02	92	130.00	12,000.00
02	12mm Mirror (Bedroom-1) • Dhar Polish • Buff	40	24	02	92	130.00	12,000.00
03	10mm Tofan Glass (Bedroom-1) • Dhar Polish • Buff	16	24	02	92	130.00	12,000.00
Total					990.00	38,400.00	
						38,400.00	
						1,600.00	
						00.00	
						40,000.00	

Remark :

Term & Conditions :

Note :

Malavir Glass
510 Solarium Business Center, VIP Road, Ward 2, Vesu, Surat, Gujarat 395007
(Mo) :- +91 99749-79279

Receipt

No. : 20230901001
Date : 01/09/2023

Received with thanks from MURTUZA TARWALA (Mo. :- +91 99749-79279)
of Rs. NINE THOUSAND NINE HUNDREDS NINETY NINE ONLY
for _____

Cash Online

₹ 9,999/-

Signature _____

Sky Connect (Website)

SKY CONNECT

Home About us Services Blogs Contact us [Book a Free Consultation](#)

Investment Philosophy 4 P's

People
Management vision and execution skill along with ability to allocate capital efficiently backed by excellent corporate governance practices.

Product
Companies with niche product/ services or having competitive moat into the industry segment in which business operate or have long and enduring product cycle which keep on expanding with new product along with margin

Price
Stock below its fair value with respect to earning potential of business.

Profit
Companies backed by strong fundamentals, display margin expansion with superior cash flow.

Investor Charter [Read More](#)

System [Read More](#)

"The individual investor should act consistently as an investor and not as a speculator."
-Ben Graham

Grievance Redressal System

+91 84010-96117
info@theskyconnect.in

Our Services

Prosperous Portfolios
At 'Prosperous Portfolios,' we're dedicated to crafting personalized investment strategies that lead to lasting prosperity.
[Read More →](#)

Emerging Portfolios
At 'Prosperous Portfolios,' we're dedicated to crafting personalized investment strategies that lead to lasting prosperity.
[Read More →](#)

Why Choose Us ?



JB Architonic (Web App, Mobile App)

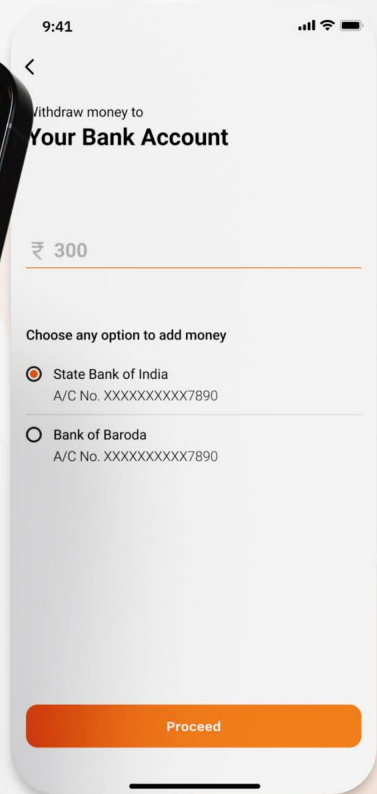
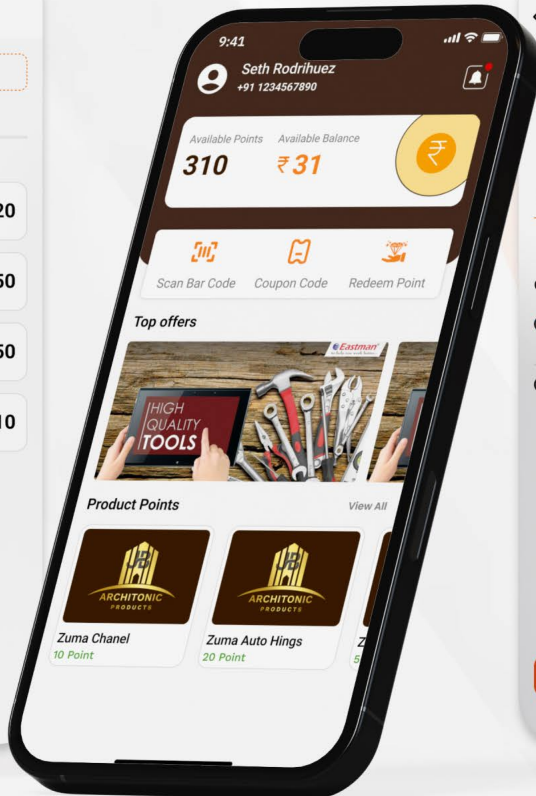
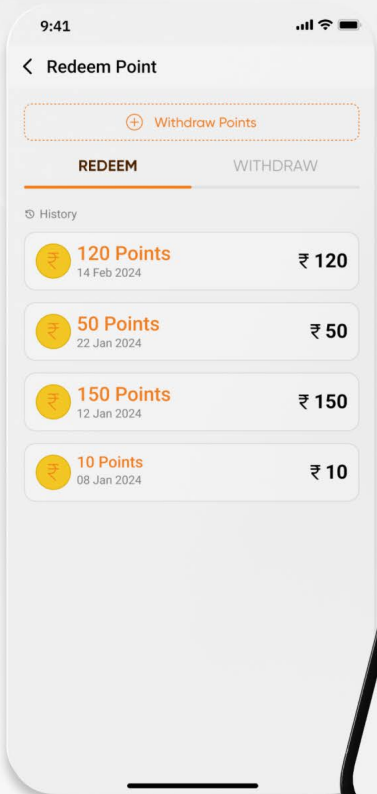
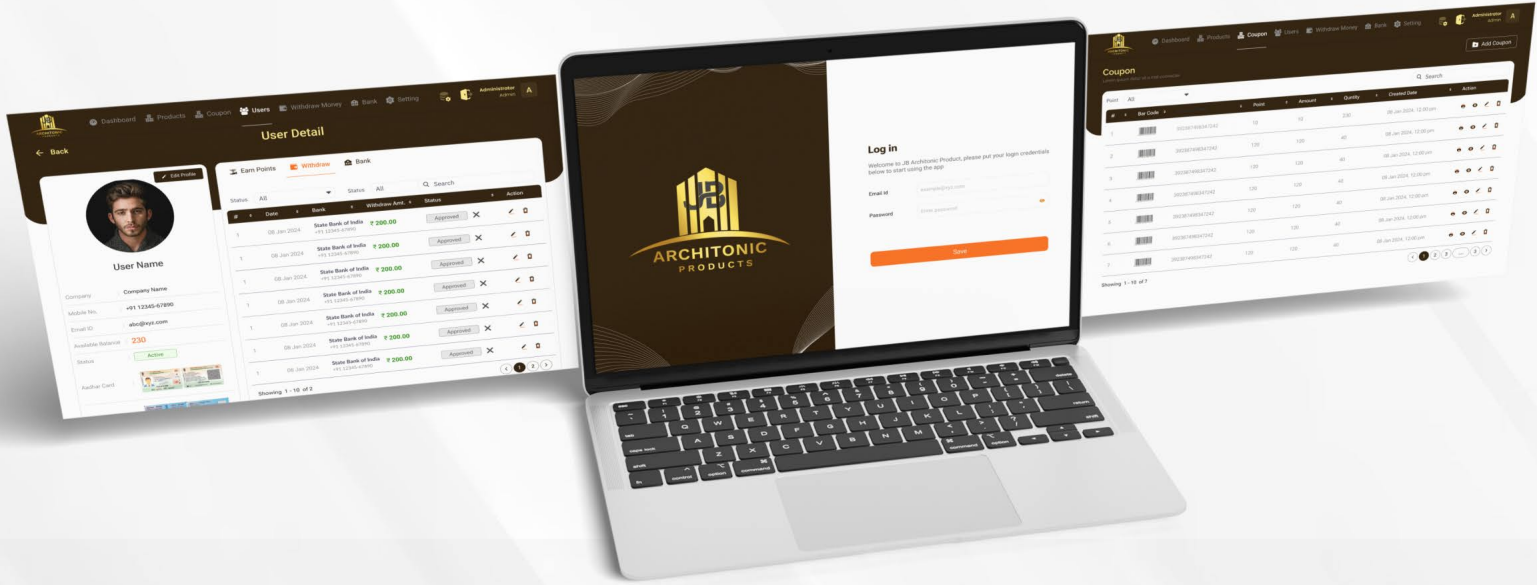

NCT Tang (Mobile App)

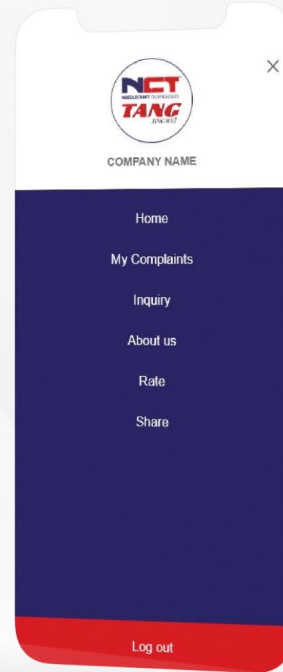

Metro Power (Mobile App)

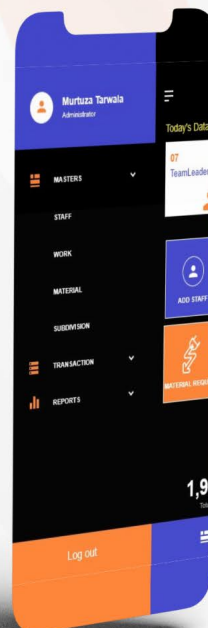
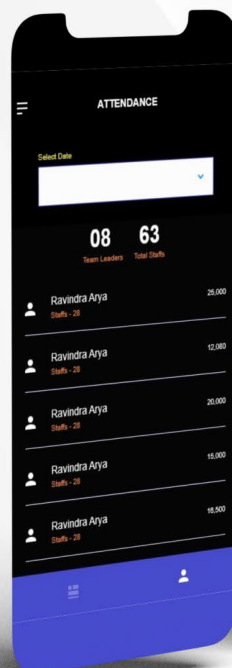

Braces N Gum Care (Website)

(BDS, MDS) (BDS, MDS)

Quality and Affordable Dentistry

Our Services



Dental Implant
[Learn More](#)



Gum Care
[Learn More](#)



Orthodontic Braces
[Learn More](#)



Smile Design
[Learn More](#)

4th May

Oral Cancer Awareness: Signs, Symptoms, and Prevention

[Learn More](#)

28th May

The Dos and Don'ts of Teeth Whitening: Expert Advice

[Learn More](#)

12th May

Oral Health for All Ages: Tips for Kids, Teens, and Adults

[Learn More](#)

[See More](#)

Call us or book your appointment today

Make your dream smile a reality!

We are situated in Citylight, one of the posh localities in Surat. Our clinic is managed by dedicated team of Dentists, an Orthodontist, Cosmetic, Aesthetic Specialist - Dr. Vikas Goyal, Periodontist & Implantologist - Dr. Neha Ajmera & visiting consultants.

[Get Appointment](#)

Toll Free Customer Care
+91 95852 52586

Toll Free Customer Care
+91 95852 52586

New Live Support!7
info@dentapro.com

braces N gum ^{care}
multi specialty dental clinic

We are situated in Citylight, one of the posh localities in Surat. Our clinic is managed by dedicated team of Dentists, an Orthodontist, Cosmetic, Aesthetic Specialist - Dr. Vikas Goyal, Periodontist & Implantologist - Dr. Neha Ajmera & visiting consultants.

Quick Links

- Dental Implants
- Dental Braces
- Gum Care treatment
- Teeth Whitening
- Invisible Braces
- Dental Veneers
- Our Achievements

Our Services

- Gum Care
- Smile Design
- Dental Implant
- Orthodontic Braces
- Blog

M 8-10, Corner Point, Opp. Sejal Appt. Citylight, Surat - 395007, Gujarat (India)

CARE

Copyrights 2024 v Care Technologies. All Rights Reserved | Developed by V care Technologies

Home About Us Dental Implants Orthodontics Braces braces  gum ^{care} Gum Care Gallery Content [Get Appointment](#)

What are dental implants

Why Choose Dental Implants?

The Procedure behind the Placement of Dental Implants

Reasons of Replacing Missing Teeth

- Replacing A Single Tooth
- Replacing Multiple Teeth
- Sinus Lift Augmentation
- Socket Preservation
- Replacing All Of Your Teeth
- Top 10 Facts About Dental Implants

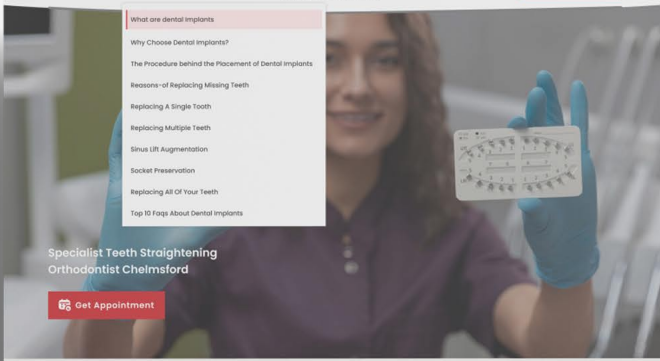



Specialist Teeth Straightening Orthodontist Chelmsford

[Get Appointment](#)

Unparalleled Experience

 **1,200+**
Happy Client

 **15+**
Year Experience

 **70+**
Doctor & Staff

 **340+**
Online Appointment



DR Neha Ajmera Goyal
(BDS, MDS)



DR Vikas Goyal
(BDS, MDS)

Quality and Affordable Dentistry

Our Services



Dental Implant
[Learn More](#)



Gum Care
[Learn More](#)



Orthodontic Braces
[Learn More](#)



Smile Design
[Learn More](#)

Changing Lives One Smile At A Time!

Welcome to Braces N Gum Care





Asshwin Dubey (Website)

NLP Mind & Business Coach

NLP is an approach to communication, self-development, and to a mental therapy based on a psychological approach that involves few mind strategies which were used by some successful individuals & they help them to reach a personal goal. It is how thoughts, language habits, and patterns of behaviors learned through experience to desired outcomes. Advantages of NLP states that all human actions are possible.

Asshwin Dubey

24+
Years of Experience

1000+
Lives Changed

10000+
Lives Transformed

90+
Business Coaching

Who am I ?

I am leading NLP Mind & Business Coach transformed lives of 10K plus individuals & coached more than 90+ business entrepreneurs & their teams help them to generate 300cr+ revenue.

How can I help

Impactful NLP Coaching

NLP is a powerful course which can transform & reprogram your entire subconscious mind. Build self confidence, build your new self image, learn to manage pain, trauma, get it, anxiety, depression, Align & achieve purpose of life.

Business Breakthrough Coaching

Develop business growth mindset, learn entrepreneur mindset. This program includes SMART goal setting, Communication, money, support building.

meet me

It's my mission to unlock 10 million lives by 2024

मेरा चेहरा अलग है तो मेरी पहचान भी अलग ही होगी और मेरी पहचान अलग है तो मेरा काम भी अलग ही होगा और मेरा काम अलग है तो मेरा इस जीवन में मुकाम भी अलग ही होगा

-Asshwin Dubey

What Happens When You Join?

- ✔ Get stress free mind disease free body
- ✔ Get rid of anxiety depression
- ✔ New Image with self confidence
- ✔ Create compelling future
- ✔ Get freedom from traumas pains phobias guilt stress worry overthinking procrastination
- ✔ Align your purpose to achieve your dream goal with law of attraction & vision board
- ✔ Get desire results & outcome in health wealth happiness relationships business careers & study

WHAT IS NLP?

N

NEURO

The state of our mind is the way we think, our nervous system and the neural pathways of our brain are affected by what we see, hear, feel, taste & smell.

L

LINGUISTIC

How we use the language and how it influences our mind and affects us. It is so related to our verbal and non-verbal language, how we communicate with others and more importantly, how we can influence others to do what we want.

P

PROGRAMMING

How we see, think, do, actions to achieve our goal of success are to how our thoughts, feelings and behaviors are. Habits, programs, and can be changed or replaced by upgrading our mind software.

Bonus

If You Register Before Timer Hits 0

Time Management

Vision Board

REGISTER NOW AT ₹999 ONLY

Postcard

spiritual guidance, straight talk, and transformational methods to change your life

SIX PSYCHOLOGICAL HUMAN NEED

WHY IT IS IMPORTANT TO KNOW AND HAVE MISSION FOR OUR OWN LIFE

Our Glimpse Seminar



portfolio

Design Portfolio

2024

Bringing Your Vision to Life

We offer a full range of design and web development services, including graphic design, UI/UX, web design, social media design, Logo Design, Branding and custom IT solutions.

Our variety of projects and clients extends from health to humanitarian sector and from public enterprises to private firm

Our team and dedicated staff and organizational policies symbolizes the virtue of our brand that is "we care"

Services Offered

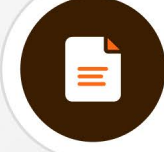
-  **UX / UI Designing**
-  **Graphic Designing**
-  **GIF Design**
-  **Branding and marketing design**
-  **Special issue, profitable book and soviniar document designing**
-  **Concept, pitch deck and theme base designing**
-  **Specialize web pages, social media strategy, technical content creation**
-  **Documentation formatting and alignment**
-  **Innovative and interactive IT tool design**
-  **Server and API integration**

 **And many more services to offer**

Foot Impact

Podiatric Doctor

Logo

Stationary Design

Brand Guidelines





FOOT IMPACT

EVERY STEP COUNTS

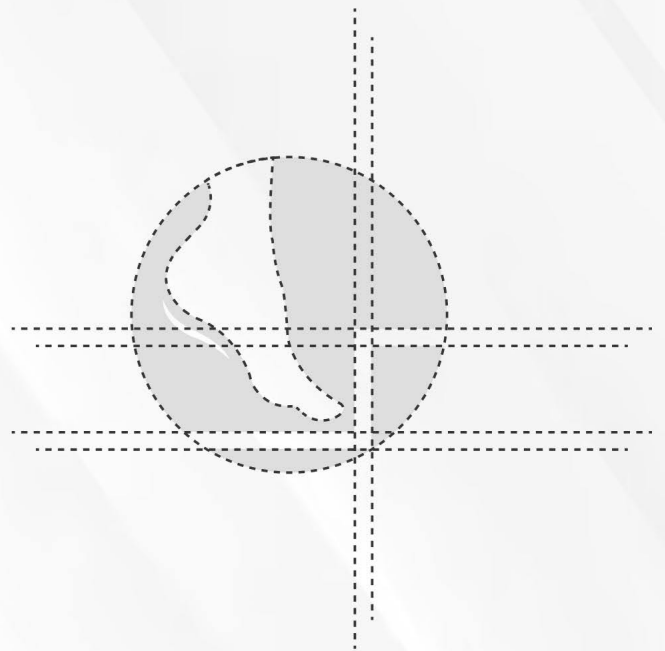
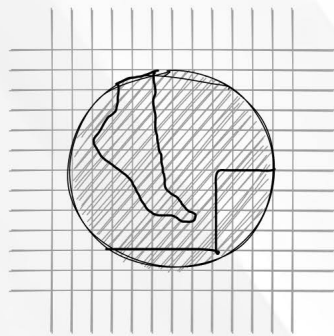
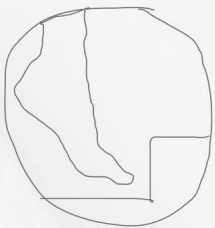

Logo & Meaning

The logo features a distinctive and symbolic depiction of a foot gracefully ascending a set of stairs, capturing the essence of progress, mobility, and wellness. The foot, rendered with precision and care, is positioned in mid-step, conveying a sense of forward momentum and movement. The stairs beneath the foot are artfully designed to signify the stages of a journey towards better foot health and overall well-being.

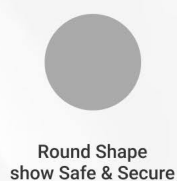

Foot



Steps



logo



FOOT IMPACT

EVERY STEP COUNTS



#DC6054

CMYK:
9%, 77%, 67%, 1%



#458AA7

CMYK:
74%, 35%, 24%, 73%

Typography

Aa

Work Sans

ABCDEFGHIJKLMNOPQRSTUVWXYZ

ABCDEFGHIJKLMNOPQRSTUVWXYZ

ABCDEFGHIJKLMNOPQRSTUVWXYZ

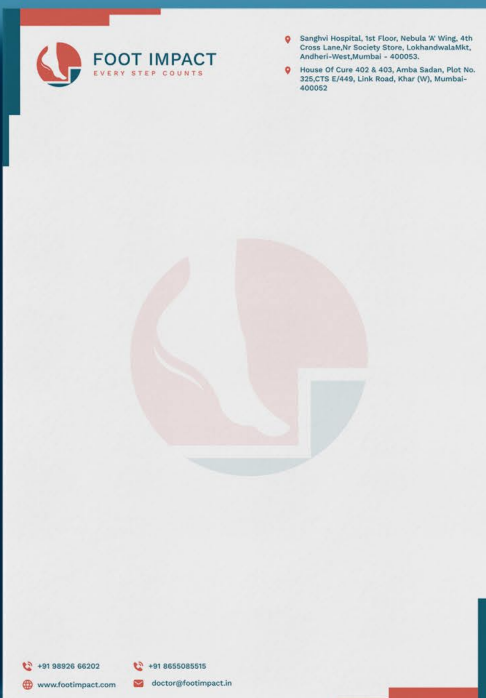



Social Media

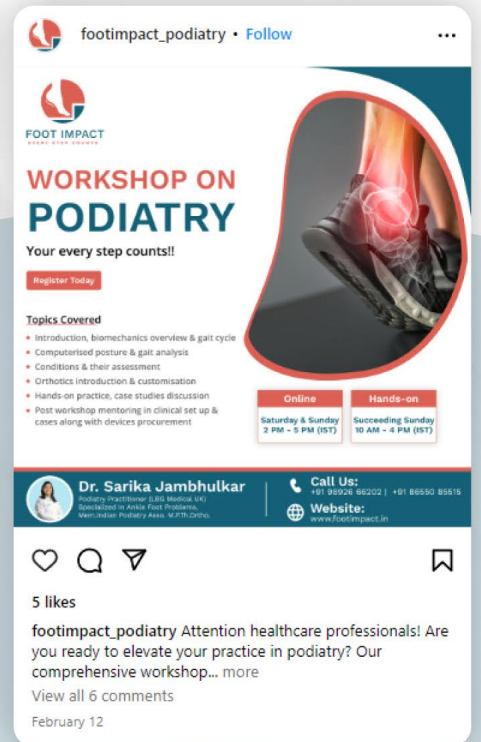
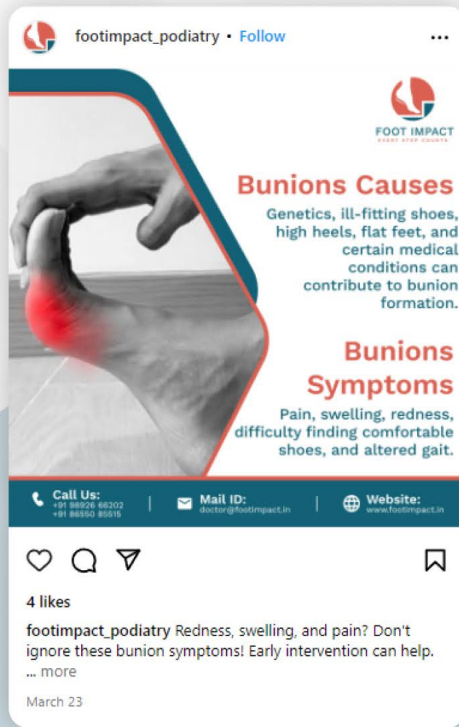

Facebook Page Design



Zaid Excel Design

Architect

Logo

Stationary Design

Brand Guidelines

Work Sans



Pain Points

- Very detailed logo with too many elements
- Lack of visibility and clarity when scaled down
- Lack of adaptability and versatility in usage
- The letter 'Z' is overpowering and name of the brand does not have enough importance

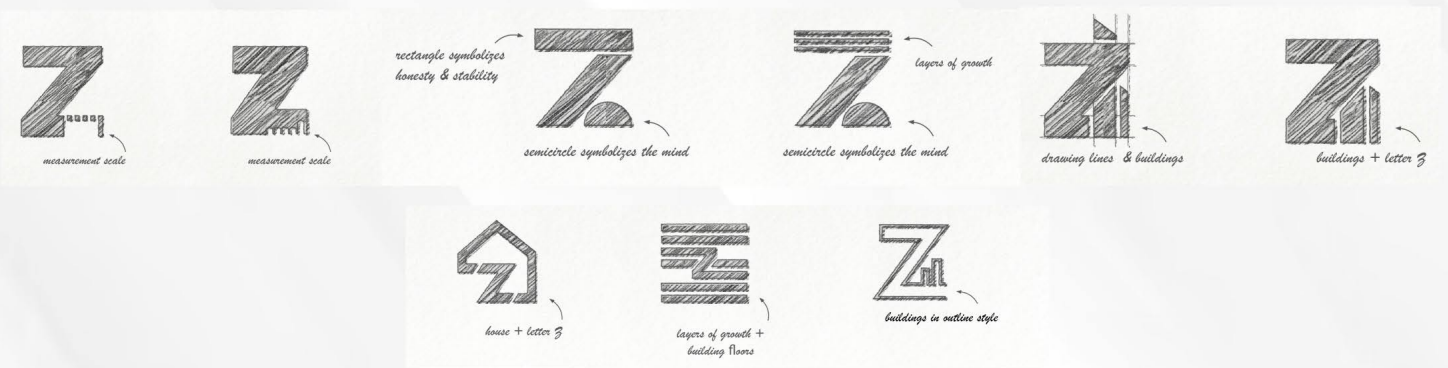

Concept Note

A minimal and simplistic approach has been taken in this option. It has a very balanced appearance while maintaining the original logo's essence, concept and the 'Z'. The symbol incorporates most elements of the original logo but with a contemporary and fresh outlook. The simplification gives it a new age feel and makes the elements more legible even when scaled down/up.





OLD



Tarsha Tech

PMS Product

Logo

Stationary Design

Brand Guidelines



Bio

Tarsha is a software company, which includes Social Media, SEO and SMO it also has CRM process softwear which will be provided as a rental. It also provides PM consultation, Arch Design, structure design, and etc

Logo Process

Name Inspiration

TARWALA SHAIKH

T S



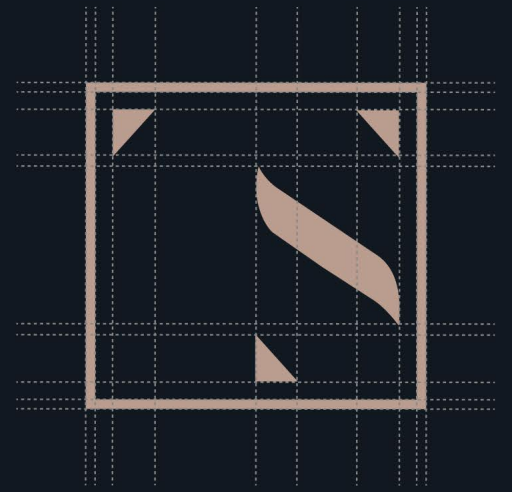

Letter T



Letter S

The Concept

Working through the logo concepts, I decided to think how I can visually show both the names (TARWALA Shaikh) in one symbol.

Structured them in such a way that they figuratively resemble arrays of a structure and the initials letter form Tarwala (letter T) and Shaikh (letter S)

Pantone Black 6 C

#101820
R. 15 G. 24 B. 32
C. 0 M. 0 Y. 0 K. 100

Pantone 4042 C

#7A5D53
R. 122 G. 93 B. 83
C. 32 M. 52 Y. 51 K. 40

Pantone Cool Gray 1 C

#D9D9D6
R. 217 G. 217 B. 214
C. 18 M. 12 Y. 15 K. 0

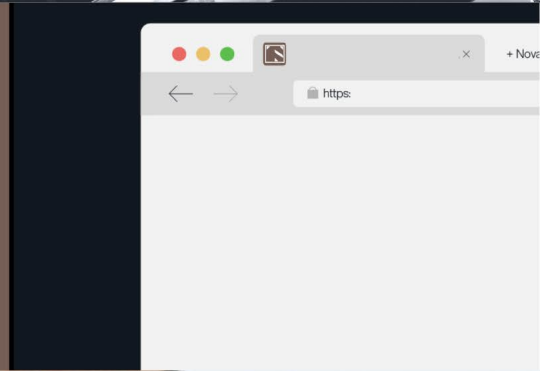
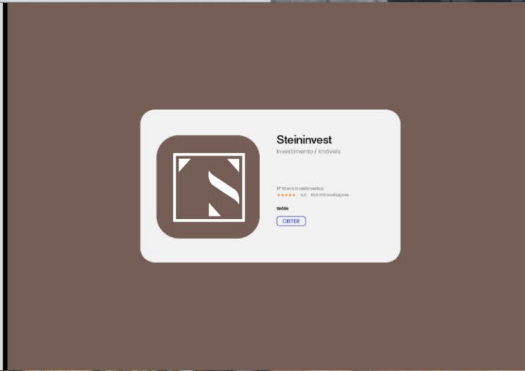
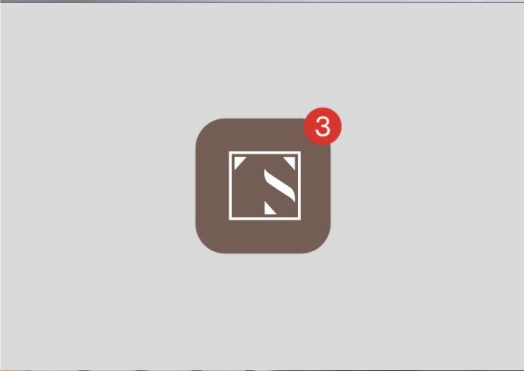

A1 Builders

Builder

Logo

Stationary Design

Brand Guidelines

Work Sans



Simple

Beautiful

Economical

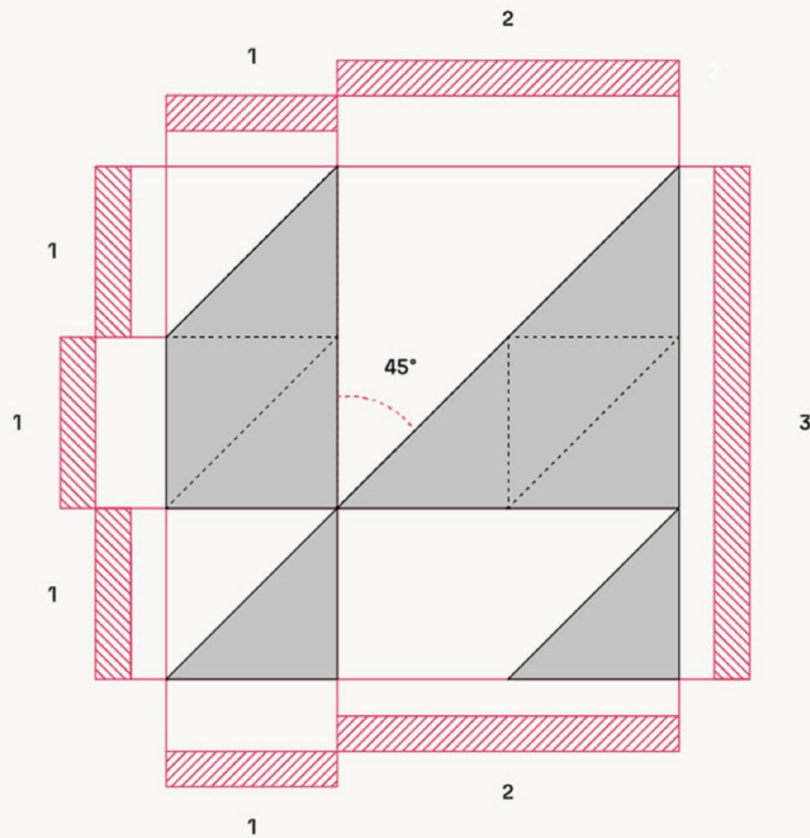

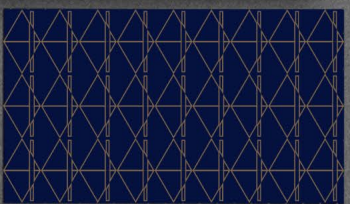
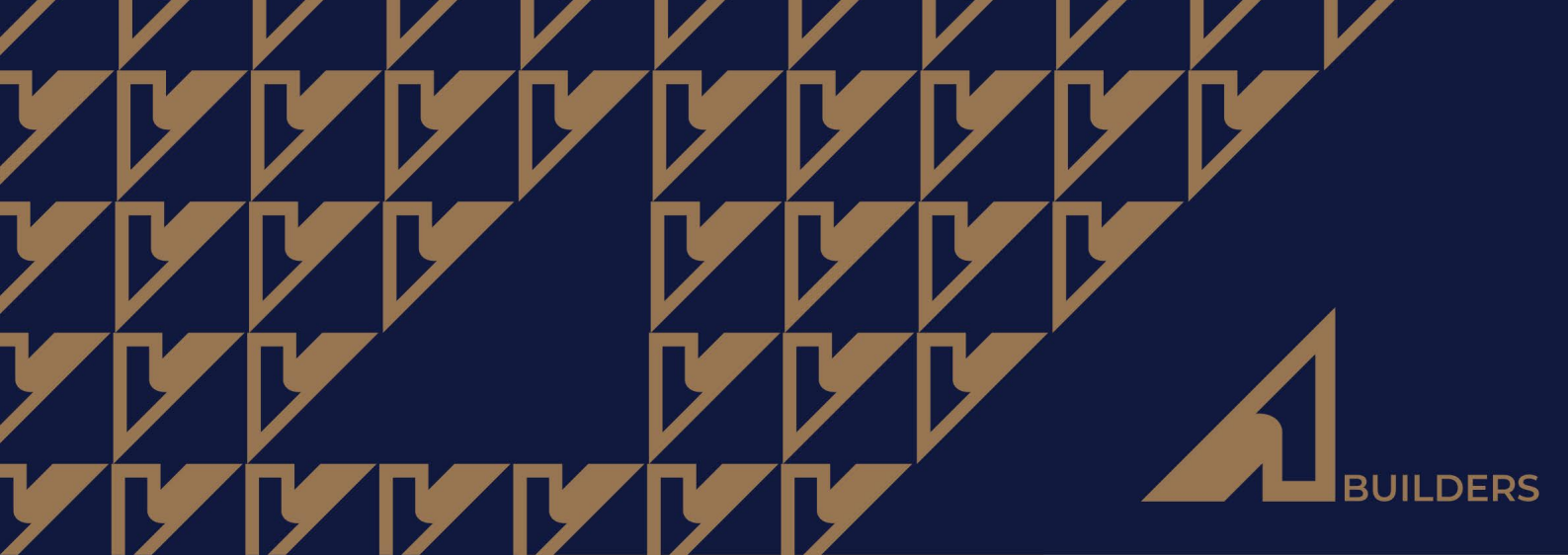



V Care Technologies

Technology Company

Logo

Stationary Design

Brand Guidelines





Mouse Pointer + VC Initial V & C

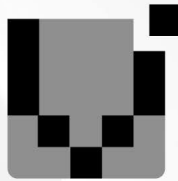

Pixels + Letter V



Tick Mark + Initial V + Upward Graph

Development

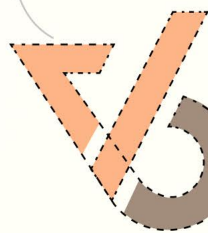

Design

V+C



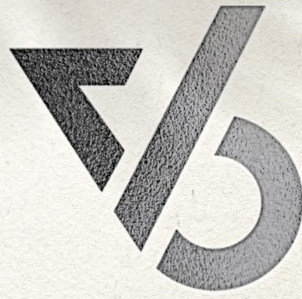

Logo & Meaning

The logo is a very simple yet interesting combination of the two letters V and C derived from the brand name “V Care.” The Orange here highlights the V and an inverted C shown in brown.

More than just a abbreviation logo, it also brings out the essence of the brand & highlights the brand service through its symbols “ < “ and “ / “ which are used in the universal representation of coding and development [</>].

The brand will be showing off its enthusiasm and determination qualities through the vibrant tangerine color. The brand will majorly make use of geometric fonts to go with the shapes of the logo.

Primary font

For brand collaterals, website headings etc.

Aa Gilroy

Secondary font

For body/supporting text, documents, etc.

Aa Work Sans



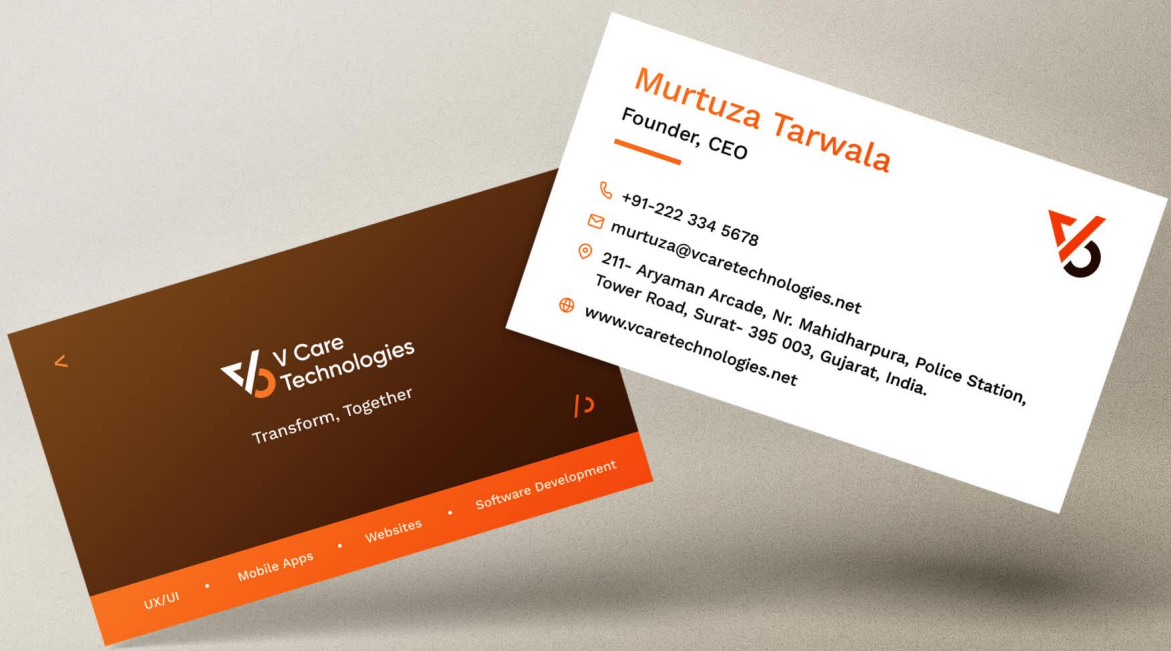

Do's & Dont's

A set of guidelines to follow for the right application of logo.



The logo should always be used in the exact ratio of logo:text. The logo should have an exclusion space around it to make it stand out.



The logo should always be used either as a whole unit or with the symbol alone.



Should not alter the orientation or the size ratio of logo:text



The logotype should not be used alone, without the text.

Social Media

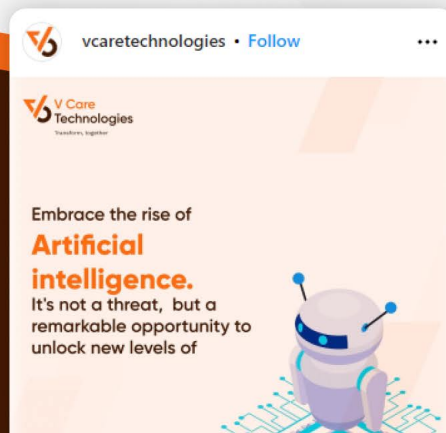

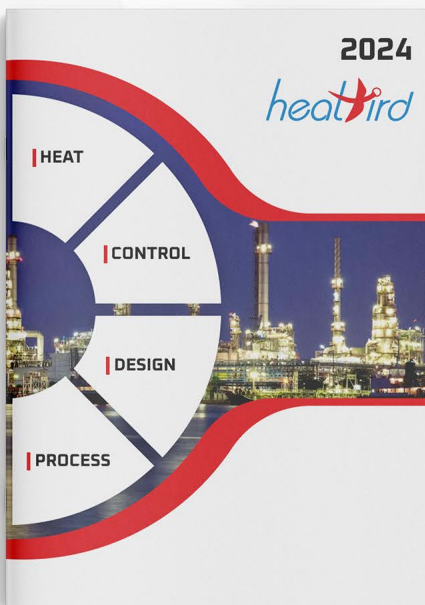

4D's

Unlike, most other heating companies who do 1 time sale we offer detailed specifications of materials, transparent and Genuine heating solutions at Fair Prices not cheap prices by working on 4Ds with your Production lines



Diagnosis
Business needs + Heating Requirements

We Diagnosis And Draft Heating Requirements that Business Needs to reach Operation lines to reach its fullest potentials.

Design
Engaging Involvement

Continuous Engaging Involvement to Desing Your Heating Products, Heating Equipment and Heating Systems

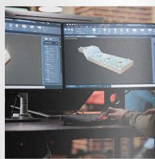

heatbird 5

Why HeatBird ?

Our Heating solutions are all about attention to details, clarity of expectations and high Productive, that provides measurable outcomes which enables your Operation lines to reach its fullest potentials.

Unlike, most other heating companies who do 1 time sale we offer detailed specifications of materials, transparent and Genuine heating solutions at Fair Prices not cheap prices by working on 4Ds with your Production lines



Our Core Values

- Quality and Efficiency
- Quick in Response and Execution Time
- Genuity & Honesty
- Process, Quality and Efficiency Driven
- Engaging Involvement

heatbird 4



Personal PROTECTIVE Equipment



tirich
LED



tirich®
LED

Since 1989
Chandan
Enterprises
**All Your Panel Accessories and
Cable Management Solutions,
Simplified!**

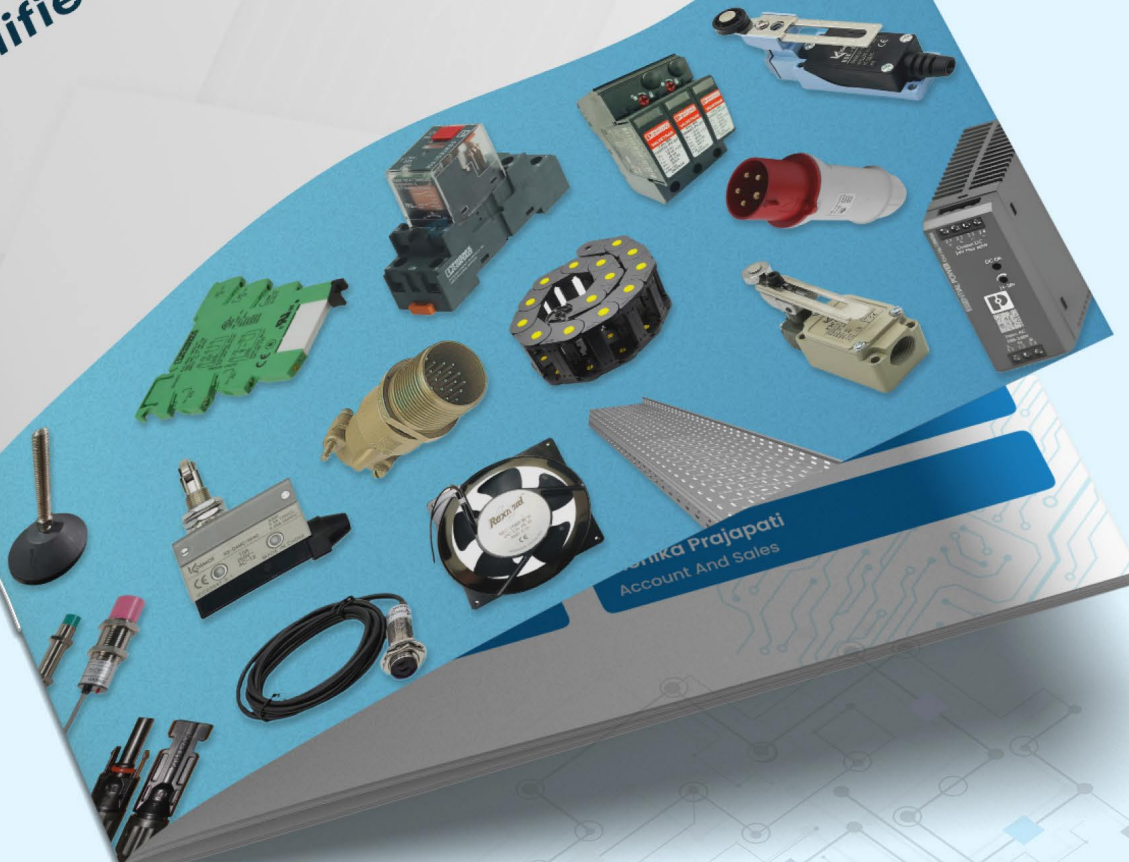

Shri Pratik Prajapati
Account And Sales

F.A.S.T App

Teachers & Student Health Care App



— National Disaster Management Authority

Icons



Disaster



Cyclone



Drought



Earthquakes



Fire



Floods



lanslide



Tsunami



First Aid Topics



Amputation



Dos-Donts



Life-Saving



Parents



Students



Burns



Call-Nearby



Choking



Dog-bite



Drowning



Fever



Bleeding



Interesting-Facts



Cramps



Psychosocial-
first-aid



Emergency



Sunburn



First-Aid-Topics



Allergy



Hypothermia old



Paralysis



Infection-Food-poisoning

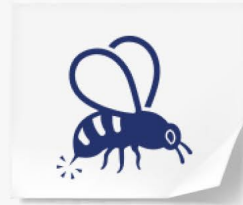

Stings-Bees



Frost-Bite



Electric-Shock



Hypothermia



Wound



Drowning



Air-Pollution

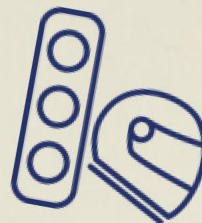

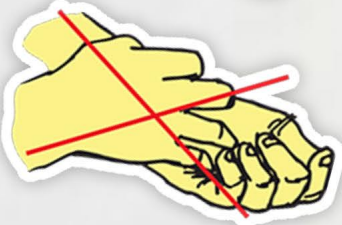

WHO

UI/UX Design, Graphic Design,
Documents Formatting And Alignment



World Health
Organization
India

— For WHO, India

Icons

Animation's / GIFs

Illustration



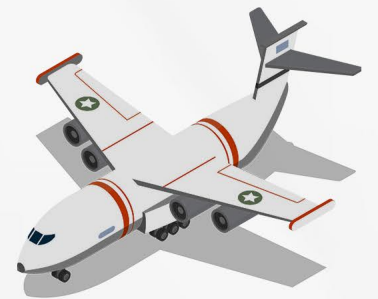
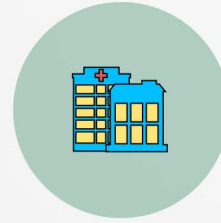

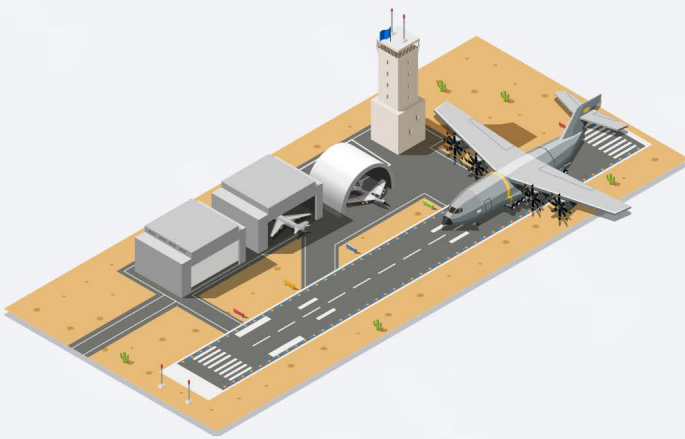
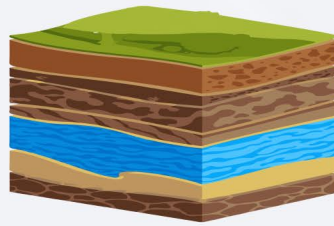

Animation's / GIFs

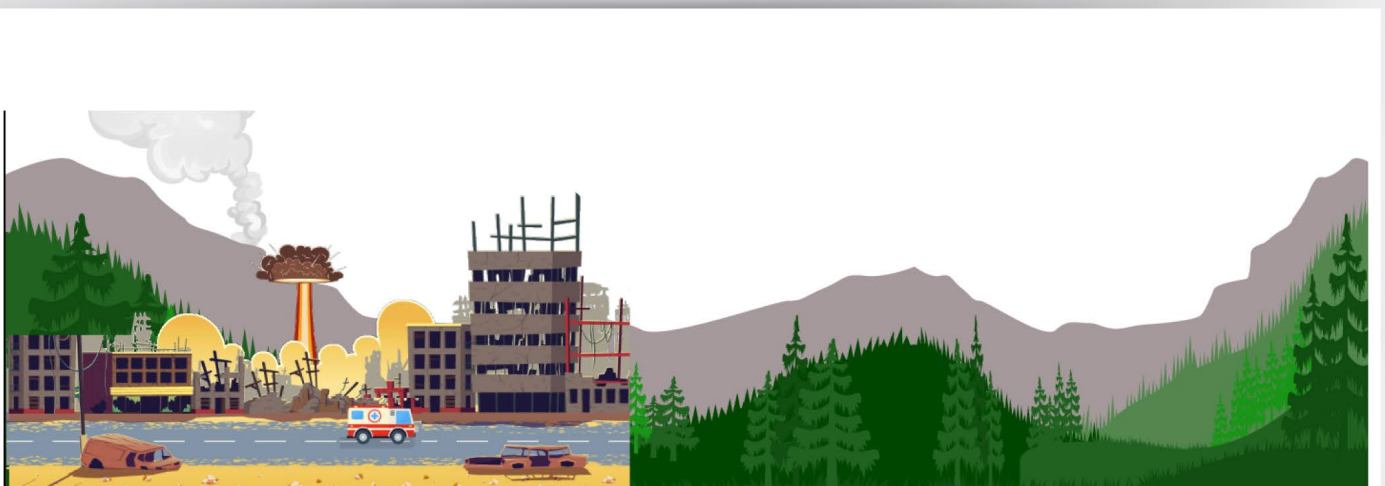







Our Client











OMKART

Best Deal on Old Mobile

tirich
LED



pooja
ETHNIC WEAR



SANGHVI WEALTH



Since 1989

Chandan
Enterprises



CHOICE CORNER
THE ONE STOP SHOP

NCT
NEEDLECRAFT TECHNOLOGIES

Urmesh[®]



WELOGICAL
SOFTWARE SOLUTIONS



Stunning Jewelry
Shine With Stunning



METRO
POWER



JARIWALA ENTERPRISES



KEYO
Tech PVT LTD

AARON[®]



LADAKH
MOUNTAIN
TOUR & TRAVELS



al

ATLAS LYNK



Novanext

Embracing the Future



MECH ENGINEERS
SINCE 1986

Client Testimonial



I had the pleasure of working with Murtuza Tarwala and his team at V Care Technologies, and I'm thoroughly impressed! As the CEO of Webledger Solutions, I needed top-notch services, and that's exactly what I got. I highly recommend V Care for exceptional website development and design. After using their services, I'm convinced that everyone will turn to them for their future needs and refer them to others.

Ajit Bansali
Founder



In 2020 we develop our website with V Care Technologies. Then after 6 months of the website we decided to have a mobile application. With V Care Technologies, what I had expected and what they have delivered it's completely highly appreciable and I am completely satisfied with their work. It reduced our cost, it has increased our revenue and it has also helped us to deliver the results to our customers at a very fast on a very fast basis.

Mansur Modan
Founder





We contacted V Care technologies surat as they are famous for building amazing websites & Apps we had a meeting together regarding the development of a website & customised online examination portal in which students can give exams online which they delivered beyond our expectations they were very cooperative with us we recommend everyone to take their services and benefit from them.

Manoj Mandavia
Principal



V Care Team have been a great support to lilacs salon for many years from the development of customised software to running and maintaining the complete software, no person can do a job so well

Ms. Jugnu Ahura
Owner



Website design, software, mobile app.. good service.

Dr Tasneem N
Coach

 **Dr. Tasneem**



V Care Technologies has been a standout web and app developer for us. His innovative approach, technical skill and commitment to delivering high-quality solutions have significantly enhanced our digital presence. We highly recommend Murtuza Tarwala for anyone seeking expert web and development services.

Yogesh Patil
Owner



V Care Technologies has been outstanding in web and app development. His technical expertise, creativity, and dedication have resulted in high-quality, user-friendly solutions for our business. We highly recommend Murtuza Tarwala for anyone seeking top-notch web and app development services.

Raja Lovo Kumar
Owner



V Care Technology demonstrated a deep understanding of website design and explained complex concepts with clarity. Their proactive approach helped optimize my marketing, resulting in significant savings. Mr. Murtuza's professionalism, punctuality, and responsiveness were exemplary, and he provided personalized advice that aligned perfectly with my business goals, making me feel valued and reassured. I will certainly recommend Mr. Murtuza within my contact sphere.

Fenil Relia
Owner





“

I highly recommend V Care Technologies for their outstanding web and app development services. Their team delivered high-quality, tailored solutions that exceeded my expectations. Professional, responsive, and results-driven, V Care Technologies is a standout firm. I'm truly impressed with their work!

Chirag Oza
Owner



“

V Care Technologies exceeded my expectations with their exceptional web development services. They delivered a fast, responsive, and visually appealing website. I highly recommend them for anyone seeking reliable and professional web solutions.

Jaysukh Dobariya
Owner



“

Hi, I'm Zaid Shaikh, founder and owner of Zaid Excel Design, where we offer interior and architectural solutions. We were struggling with team management, but Murtuza Tarwala from V Care Technologies listened to our needs and delivered the perfect custom software. Now, I can track my team's progress, their project locations, and even allow clients to see their work's status. I'm very satisfied with the service provided by V Care Technologies.

Zaid Shaikh
Owner



THANK YOU

Contact Us



+91 92650 85219



 +91 99749 79279

 +971 55 997 0754



info@vcaretechnologies.net



www.vcaretechnologies.net



Follow on @vcaretechnologies